

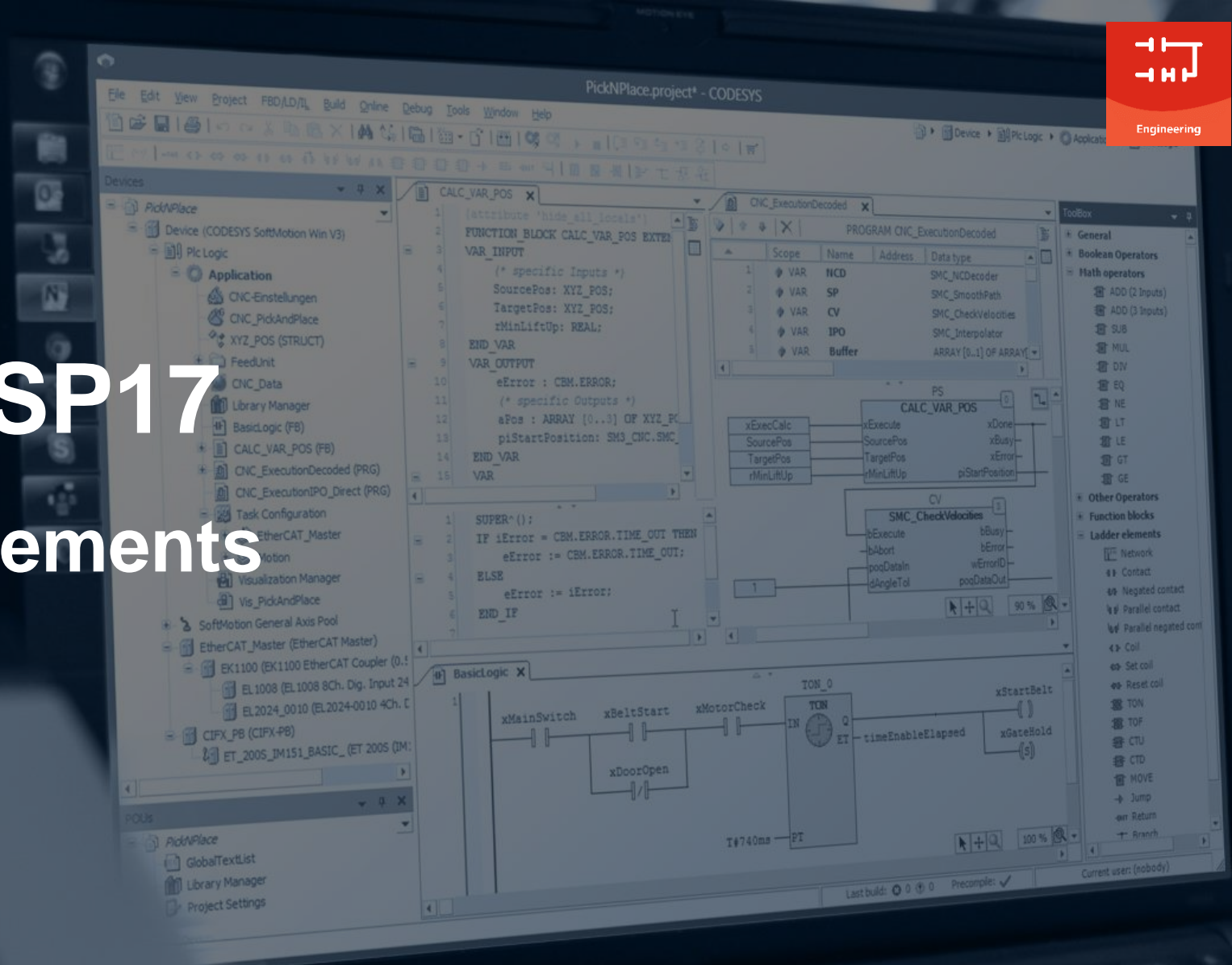

# CODESYS V3.5 SP17

## Features and Improvements



**1**

**Engineering**

**2**

**Runtime**

**3**

**Visualization**

**4**

**Motion CNC Robotics**

**5**

**Fieldbus**

**6**

**Communication**

## Overview

- **CFC improvements**
- **Security improvements**
- **Signed Libraries / Library Manager**
- **Further improvements**
- **Modularization of the CODESYS Development System**

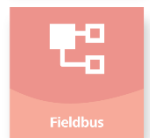
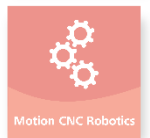
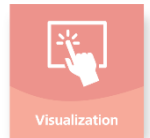
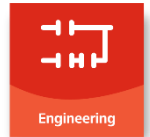

# CFC improvements

## General space optimization

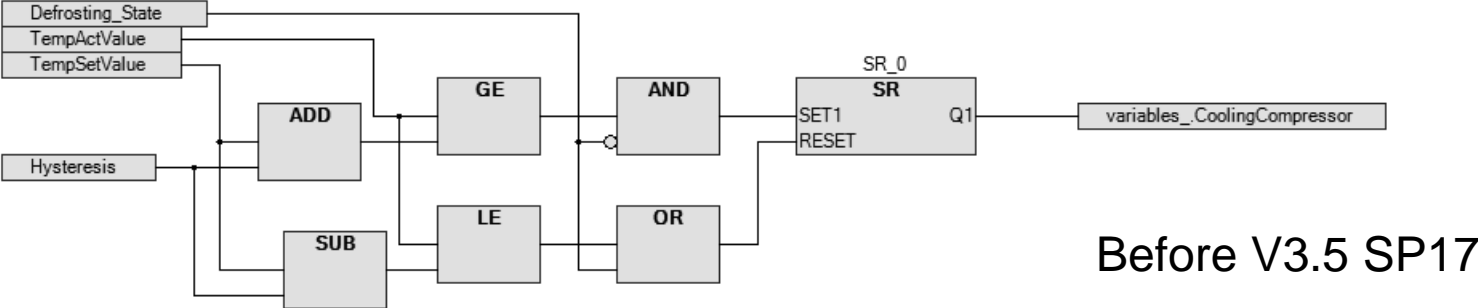

Signal\_management    Defrosting

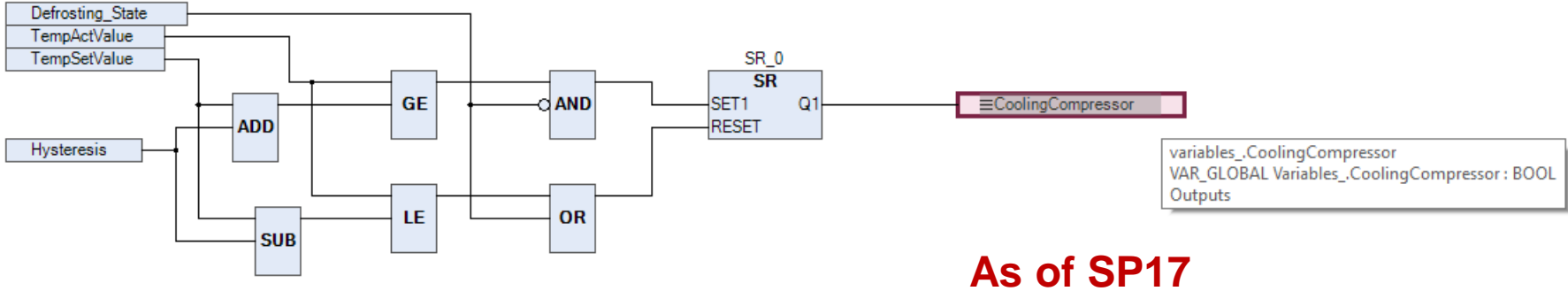

Signal\_management    Defrosting

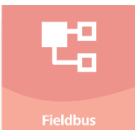
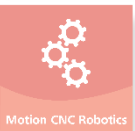

# CFC improvements

- Dark theme

```
1 PROGRAM PLC_PRG
2 VAR
3   SR_0: SR;
4   Hysteresis: REAL:=1.0;
5   Valve1:MyValveType;
6   Valve2:MyValveType;
7   Ampel1:DUT;
8   Ampel2:DUT;
9 END_VAR
```

- Pin rearrangement by drag and drop

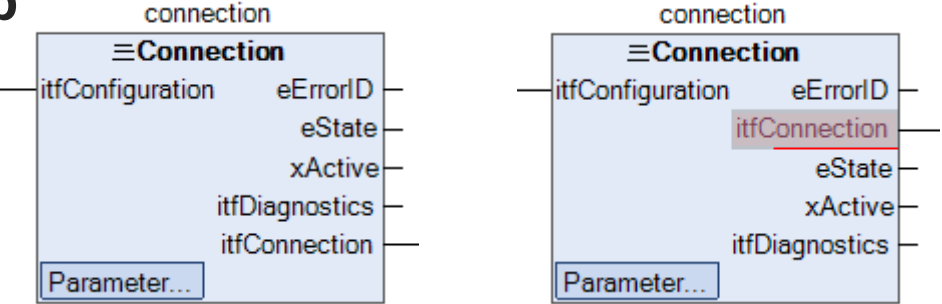

## CFC improvements

- Increased drop area for connections
- Keyboard shortcuts
- Dropping objects and symbols into the canvas

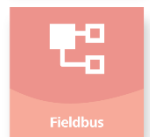
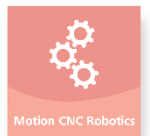
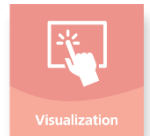

## Signed libraries

- **Supported since CODESYS V3.5 SP15**
  - Simplification of former signing process with public/private key files
  - Now based on certificates
- **Unsigned libraries: now with restrictions in CODESYS**
  - No scripting in library documentation (since SP15)
  - Embedded files from unsigned libraries cannot be opened (new in SP17)
- **Signed CODESYS libraries**
  - In SP16: some
  - In SP17: all  
(Exception: individual libraries with dependencies to libraries < SP17)

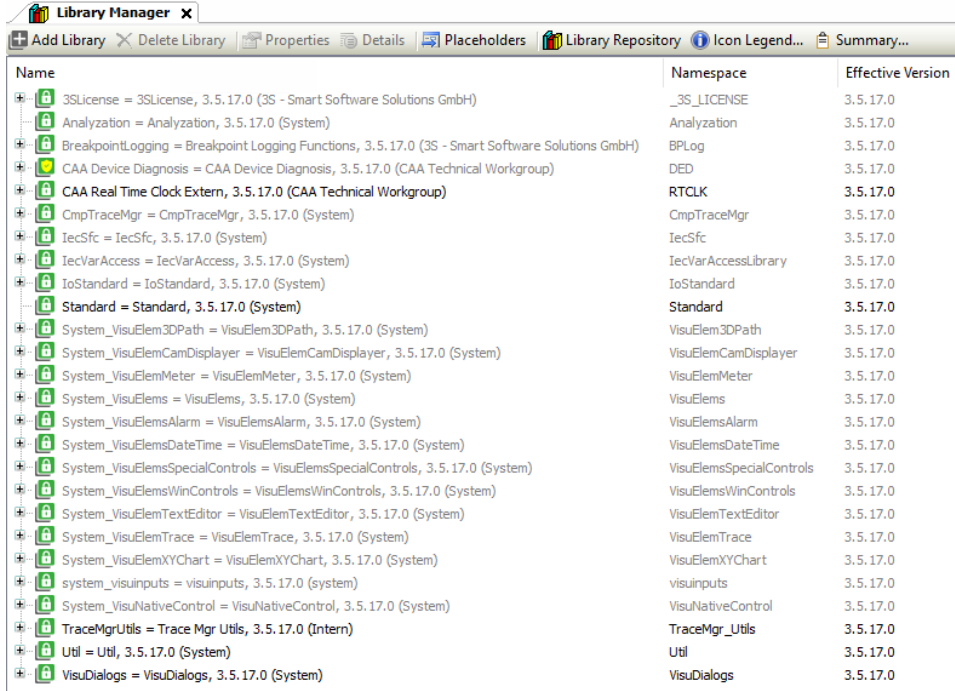

Name	Namespace	Effective Version
3SLicense = 3SLicense, 3.5.17.0 (3S - Smart Software Solutions GmbH)	__3S_LICENSE	3.5.17.0
Analysisation = Analysisation, 3.5.17.0 (System)	Analysisation	3.5.17.0
BreakpointLogging = Breakpoint Logging Functions, 3.5.17.0 (3S - Smart Software Solutions GmbH)	BPLog	3.5.17.0
CAA Device Diagnosis = CAA Device Diagnosis, 3.5.17.0 (CAA Technical Workgroup)	DED	3.5.17.0
CAA Real Time Clock Extern, 3.5.17.0 (CAA Technical Workgroup)	RTCLK	3.5.17.0
CmpTraceMgr = CmpTraceMgr, 3.5.17.0 (System)	CmpTraceMgr	3.5.17.0
IecSfc = IecSfc, 3.5.17.0 (System)	IecSfc	3.5.17.0
IecVarAccess = IecVarAccess, 3.5.17.0 (System)	IecVarAccessLibrary	3.5.17.0
IoStandard = IoStandard, 3.5.17.0 (System)	IoStandard	3.5.17.0
Standard = Standard, 3.5.17.0 (System)	Standard	3.5.17.0
System_VisuElem3DPath = VisuElem3DPath, 3.5.17.0 (System)	VisuElem3DPath	3.5.17.0
System_VisuElemCamDisplayer = VisuElemCamDisplayer, 3.5.17.0 (System)	VisuElemCamDisplayer	3.5.17.0
System_VisuElemMeter = VisuElemMeter, 3.5.17.0 (System)	VisuElemMeter	3.5.17.0
System_VisuElems = VisuElems, 3.5.17.0 (System)	VisuElems	3.5.17.0
System_VisuElemsAlarm = VisuElemsAlarm, 3.5.17.0 (System)	VisuElemsAlarm	3.5.17.0
System_VisuElemsDateTime = VisuElemsDateTime, 3.5.17.0 (System)	VisuElemsDateTime	3.5.17.0
System_VisuElemsSpecialControls = VisuElemsSpecialControls, 3.5.17.0 (System)	VisuElemsSpecialControls	3.5.17.0
System_VisuElemsWinControls = VisuElemsWinControls, 3.5.17.0 (System)	VisuElemsWinControls	3.5.17.0
System_VisuElemTextEditor = VisuElemTextEditor, 3.5.17.0 (System)	VisuElemTextEditor	3.5.17.0
System_VisuElemTrace = VisuElemTrace, 3.5.17.0 (System)	VisuElemTrace	3.5.17.0
System_VisuElemXYChart = VisuElemXYChart, 3.5.17.0 (System)	VisuElemXYChart	3.5.17.0
system_visuinputs = visuinputs, 3.5.17.0 (system)	visuinputs	3.5.17.0
System_VisuNativeControl = VisuNativeControl, 3.5.17.0 (System)	VisuNativeControl	3.5.17.0
TraceMgrUtils = Trace Mgr Utils, 3.5.17.0 (Intern)	TraceMgr_Utils	3.5.17.0
Util = Util, 3.5.17.0 (System)	Util	3.5.17.0
VisuDialogs = VisuDialogs, 3.5.17.0 (System)	VisuDialogs	3.5.17.0



## Library Manager

- **New function in the Library Manager:  
Display of all transitively referenced  
libraries in the project**

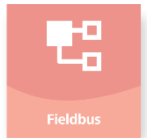
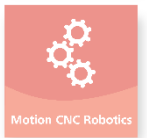
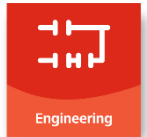
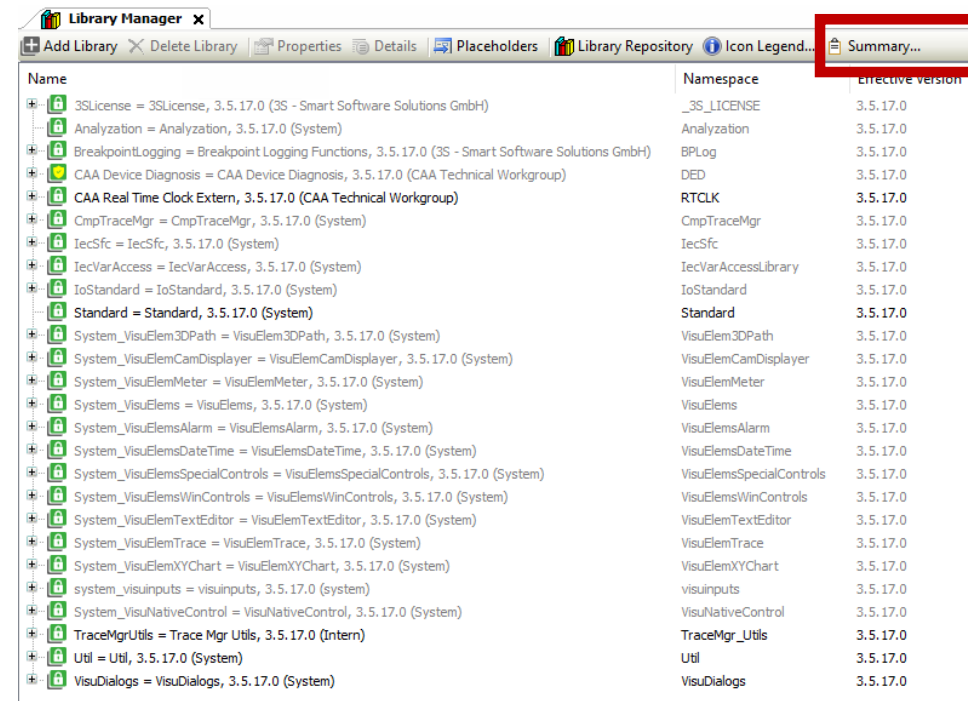
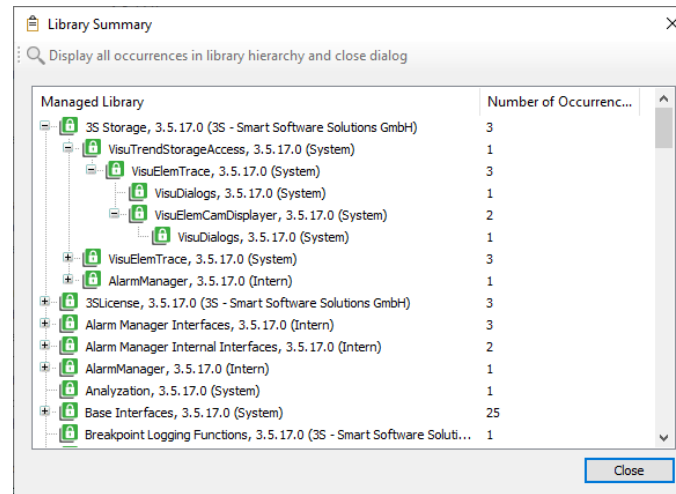



## Further improvements

- **Compare:** Allow the comparison of two arbitrary objects
- **Logger:** Filter by component  
➔ Improved usability

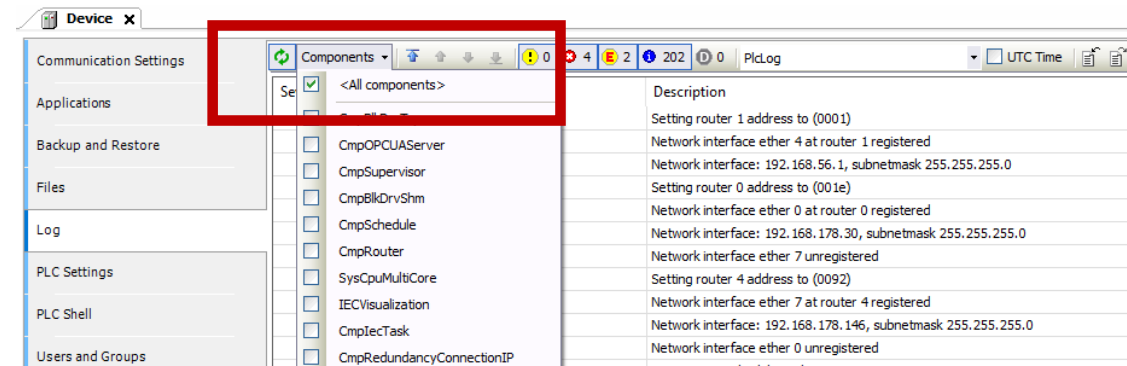

- **Preparation for new language features**
  - List of reserved keywords as of SP17  
e.g. LDATE, CHAR, WCHAR
  - Usage ➔ Compiler warnings
  - Compiler errors as soon as new language features are available

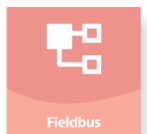
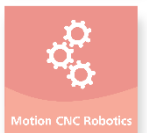
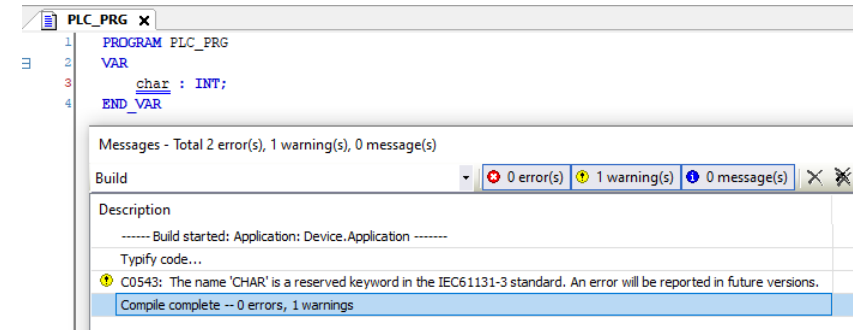

## Further improvements

- **Acceleration of project load**
  - Language model stored as additional file (similar to compile information)
    - 15% - 35% faster loading of project files
- **General acceleration**
  - Blocking of certain operations avoided
    - Significantly faster reaction after project load / download
- **Re-work of the Build menu**
  - Easier usage
  - Former commands still available (via Customize command)

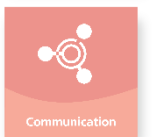
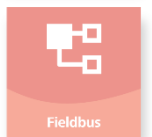
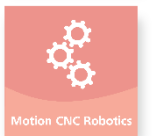
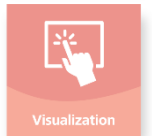
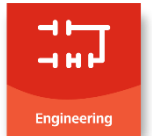
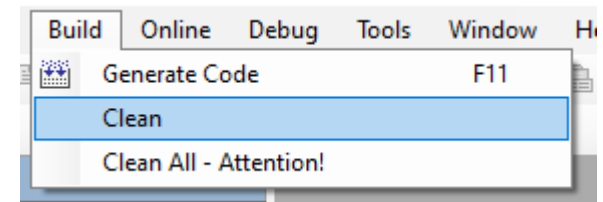

## Further improvements

- Watch list:**  
**Structured display of inherited variables of an FB**

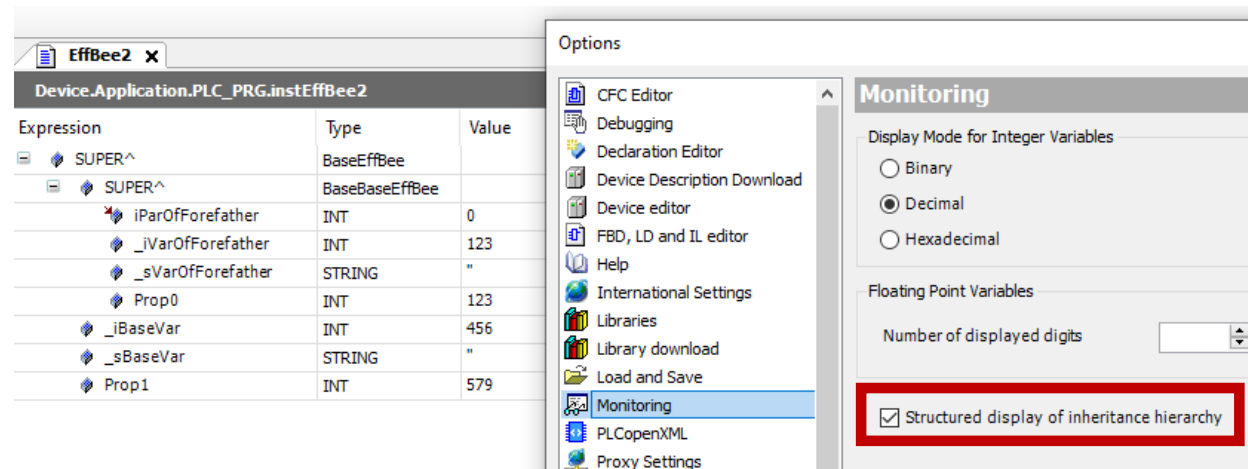

- Force list:**  
**Display of recent process value of a forced variable**

Expression	Type	Value	Prepar...	Overwritten value at start of cycle	Overwritten value at end of cycle
Device.Application.PLC_PRGj	DINT	F 55		55	1923
Device.Application.PLC_PRG.inst_di	DINT	F 78		78	1923

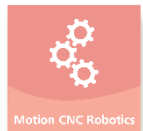
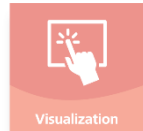

## Further improvements

- Memory view: Search for specific values in the memory of the IEC application

- Supported in Core Dump, too

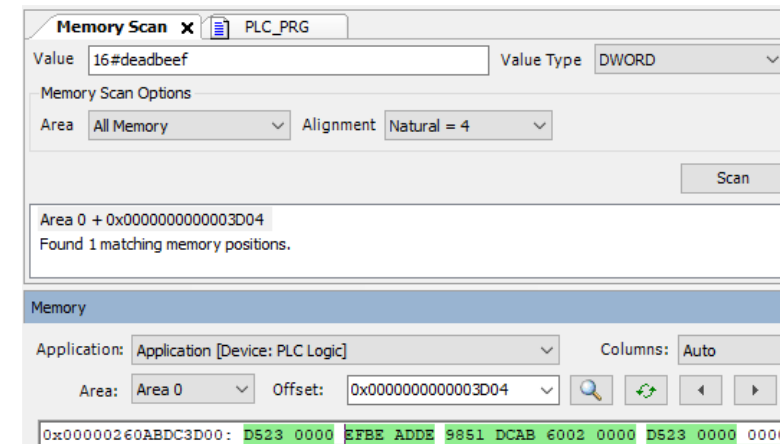

- Trace

- Simplified adding and editing of variables
- Improved work with multiple diagrams
- Improved usage of cursor

Configuration Add Variable			
Name	Cursor 1	Cursor 2	Delta
Diagram 1			
<input checked="" type="checkbox"/> PLC_PRG.i	38693	38699	Δ6
Diagram 2			
<input checked="" type="checkbox"/> PLC_PRG.j	38693	38699	Δ6

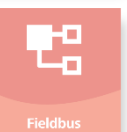
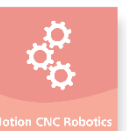
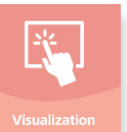
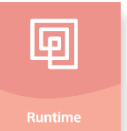
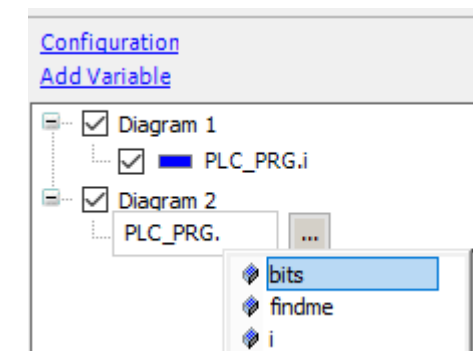

## Modularization of the CODESYS Development System

- **CODESYS Development System**
  - Unmodifiable core system: "CODESYS Essentials"
    - Mandatory in order to work
  - Various individual modules
    - Installed with the standard setup
    - Own versioning (4.x.x.x)
  - Update of individual modules possible without changing "CODESYS Essentials"
    - Functional updates at any time
    - Immediate benefit from improvements

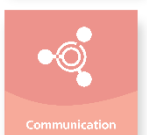
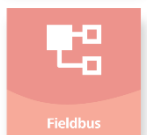
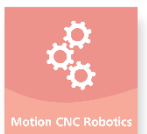
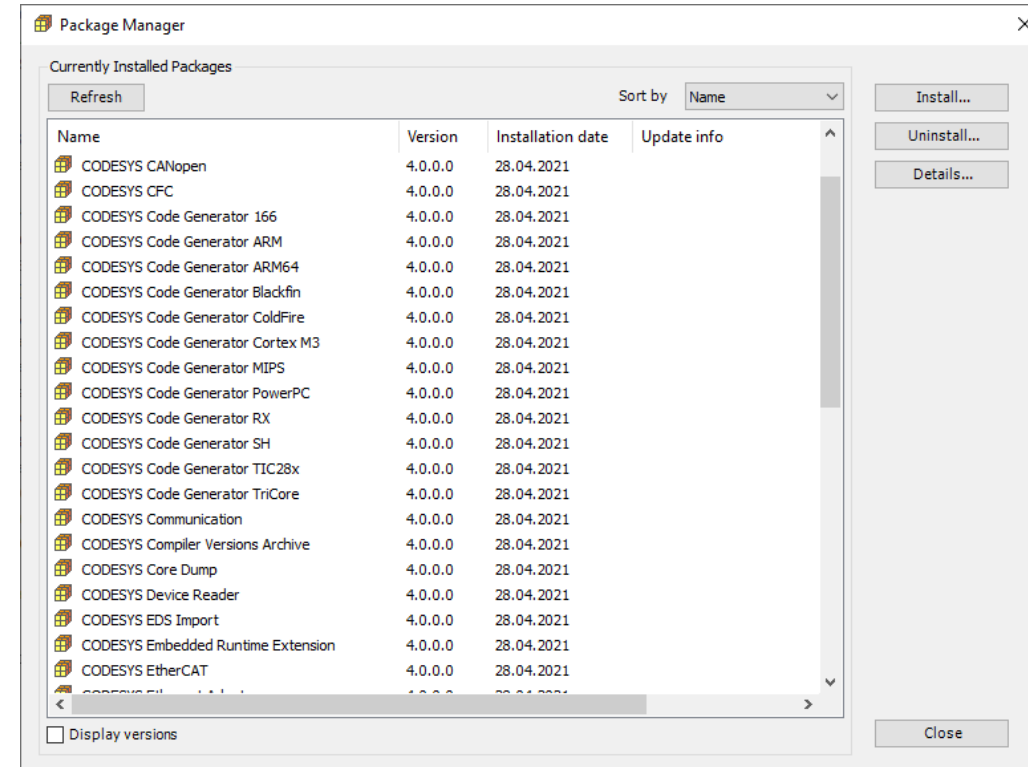

## Modularization of the CODESYS Development System

### ■ CODESYS Installer

- New executable delivered with the setup
- Grouping of required add-on components into so-called "installations"
- Creating customized versions with only desired components
- Simultaneous usage of versions for productive and experimental use
- Reload of missing components possible  
→ Deployment server

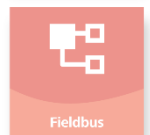
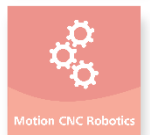
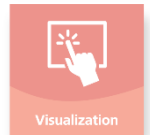
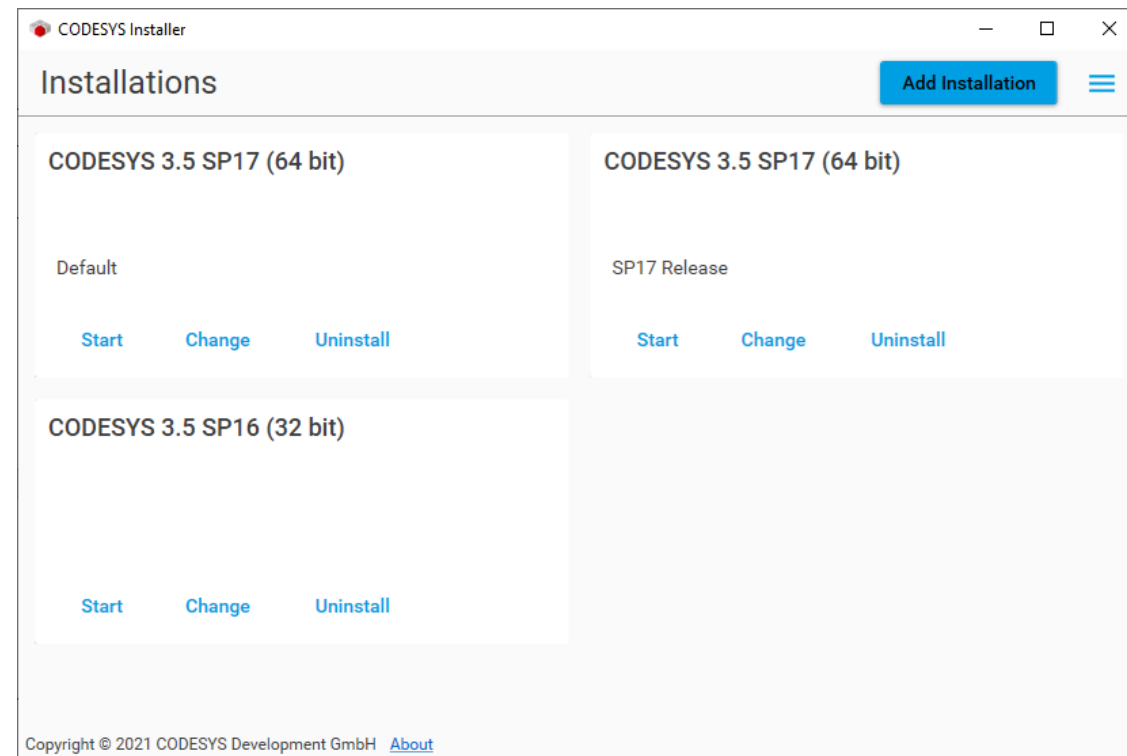

## Modularization of the CODESYS Development System

- **Signed add-on Packages**
  - All packages with native CODESYS add-ons are signed  
→ Packages can be trusted.
  - Check within the CODESYS Installer and the Package Manager
  - Result similar to signed libraries
    - **Green:** Certificate / time stamp **certificate by a CA**  
→ Both certificates are valid and not expired.  
→ Package can be installed without any concern.
    - **Yellow:** Certificate is **self-signed, not signed or expired**, timestamp is not trustworthy.  
→ Package can only be installed after user confirmation.
    - **Red:** Certificate does not match the content.  
→ Package cannot be installed.

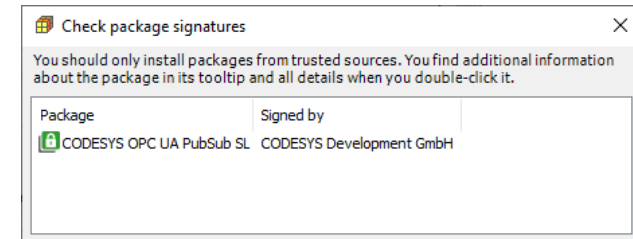
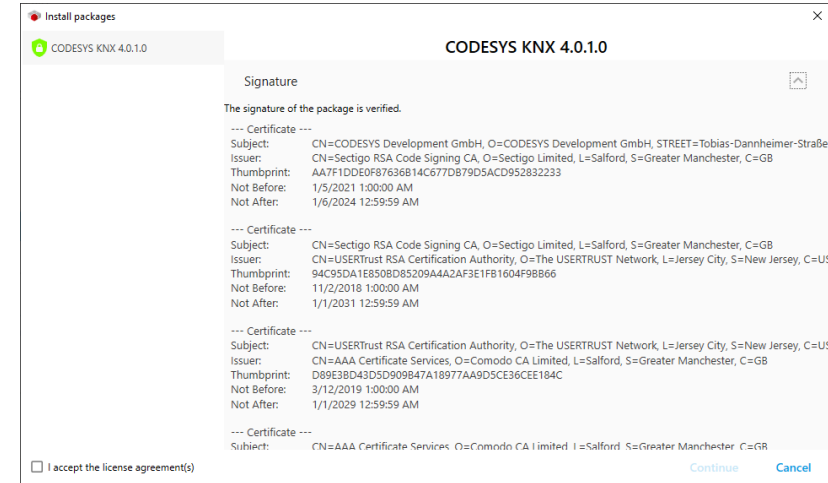

Engineering



Runtime



Visualization



Motion CNC Robotics



Fieldbus



Communication

1

**Engineering**

2

**Runtime**

3

**Visualization**

4

**Motion CNC Robotics**

5

**Fieldbus**

6

**Communication**



## Overview

- **OPC UA Server/Client**
- **Firmware update**
- **Modularization**
- **Update CODESYS Control RTE SL**
- **Further improvements**

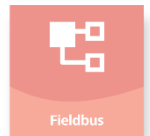
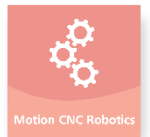
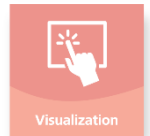
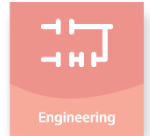

## OPC UA Server / Client

- Support of OPC UA Methods
- Support of OPC UA Alarms & Conditions
- Support of user-defined information models / companion specifications
- Implementation of new security profiles defined in OPC UA 1.04

Find detailed information in the section [Communication](#)

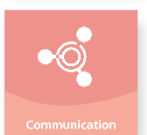
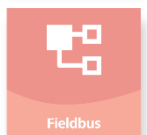
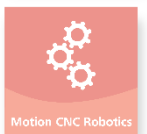
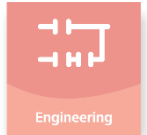

## Firmware update

- **Backup / restore / update of the complete runtime system**
  - Main use cases
    - Update of the CODESYS runtime with backup of application, certificates, and licenses
    - Backup / restore of the CODESYS runtime including backup of application, certificates, and licenses
  - Introduction of a new „Device management service“ running stand-alone or as component of a runtime with backend for access to local and remote PLCs
  - Introduction of a generic archive format (including manifest and packages)
    - Other firmware parts (OS parts, drivers, external software) could be included, but not scope of development so far
  - Client implementation in development

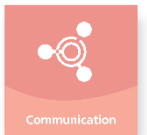
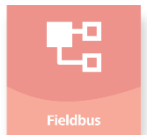
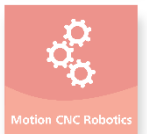
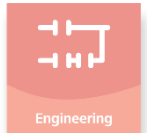

## Modularization

- **Independent releases of Linux-based single license runtimes**
  - Release of new features / improvements independent from main version (CODESYS Essentials)
  - Version changed to **V4.x.x.x**
  - No compatibility break
  - Runtimes still based on V3.5.x.x Runtime Toolkit



Wago Touch  
Panels 600

Download >

### CODESYS Control for V

This product allows users to program diff using the free CODESYS Development Sy:

Version: 4.1.0.0

Order number: 2302000038



Engineering



Runtime



Visualization



Motion CNC Robotics



Fieldbus



Communication

## Update CODESYS Control RTE SL

- **Multicore support**
  - Distribution of the application on multiple CPU cores
  - Selection of cores during setup
  - Task group configuration and core assignment within IDE
- **New drivers**
  - Support of new Peak CAN PCI Express cards
  - Support of Innodisk CAN PCI Express cards

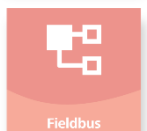
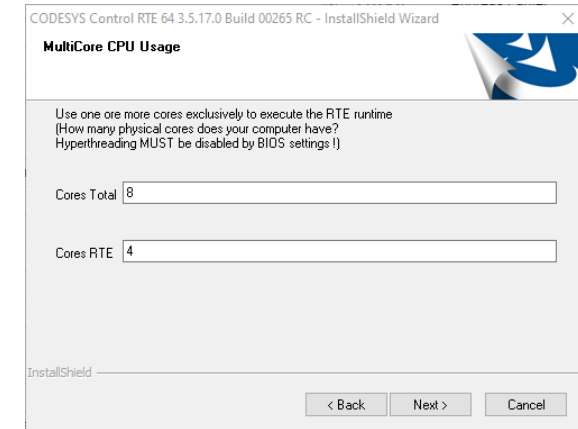

## Further improvements

- **CodeMeter®: Support of CodeMeter Universal Firm Code**
  - New generic firm code introduced by WIBU for all container types (dongle, SoftContainer, cloud)
  - Necessary for CodeMeter Runtime Support for Linux ARM
  - Due to compatibility issues only released for Linux ARM runtime
- **User Management**
  - Enable online user management by default
- **Integration of redundancy component in single-licensed runtimes**
- **Major update of CODESYS Control for PLCnext SL**
  - Bug fixes within Axioline configuration
  - Support of retain memory
  - Support of Smart Elements modules
  - Bug fix for problems with thread priorities
- **VxWorks**
  - Support of 64-bit targets on VxWorks 7

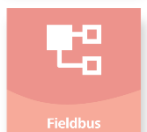
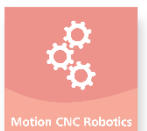
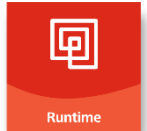
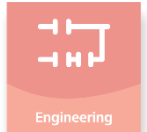

## Further improvements

- Logging of user actions
  - Login successful / failed / logout
  - Download / create / start / stop / reset / delete application

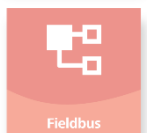
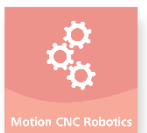
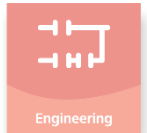
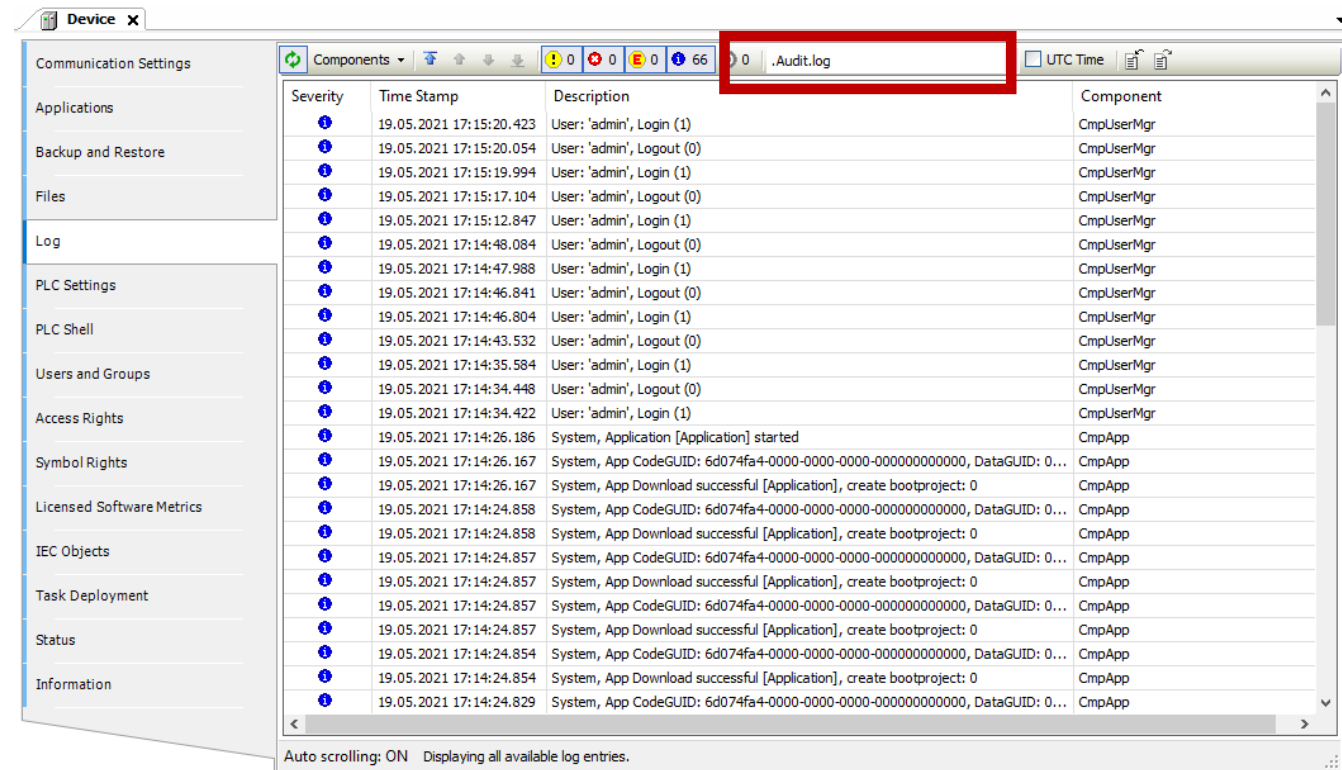

1

**Engineering**

2

**Runtime**

3

**Visualization**

4

**Motion CNC Robotics**

5

**Fieldbus**

6

**Communication**



## Overview

- **Overlay function in the CODESYS TargetVisu**
- **OPC UA Client support in CODESYS HMI SL**
- **HMI Redundancy**
- **Improvements of trend / alarm management**
- **Further improvements**

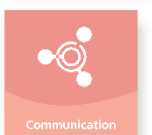
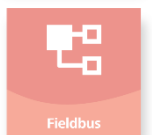
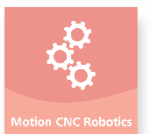
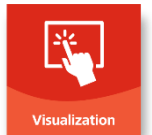
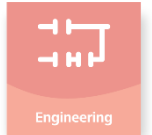

## Overlay function in the CODESYS TargetVisu

- **Dynamic internal rotation for all elements** (includes groups, frames, and native controls)
- **Time animations**
  - Smooth flying in of a menu independent of the visualization task
  - Smooth transitions for dialog fade in/out
  - Update of animated images such as GIFs/SVGs independently of the visualization task
- **Free positioning of elements in all dimensions**
  - Dialog opens over browser control
  - Crosshairs can be placed over camera image with visualization elements
- **Hardware accelerated drawing of TargetVisu (using GPU)**
- **Enabled by default in new projects - if supported by device**
- **Precondition: Qt installed on the target device**
- **For details, see video at <https://youtu.be/C-7RQW-jmDk>**

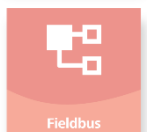
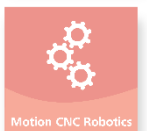
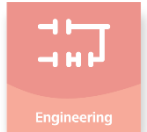
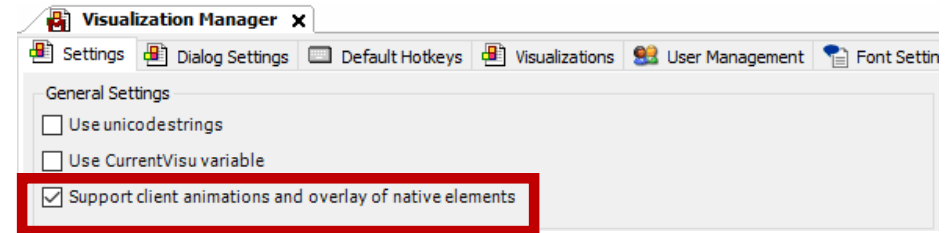

## CODESYS HMI SL with OPC UA Client

### CODESYS HMI SL

- Connecting to available OPC UA server
- Browsing the published data
- Read / write access to the data via visualization

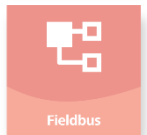
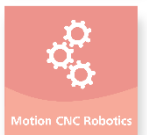
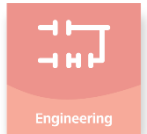
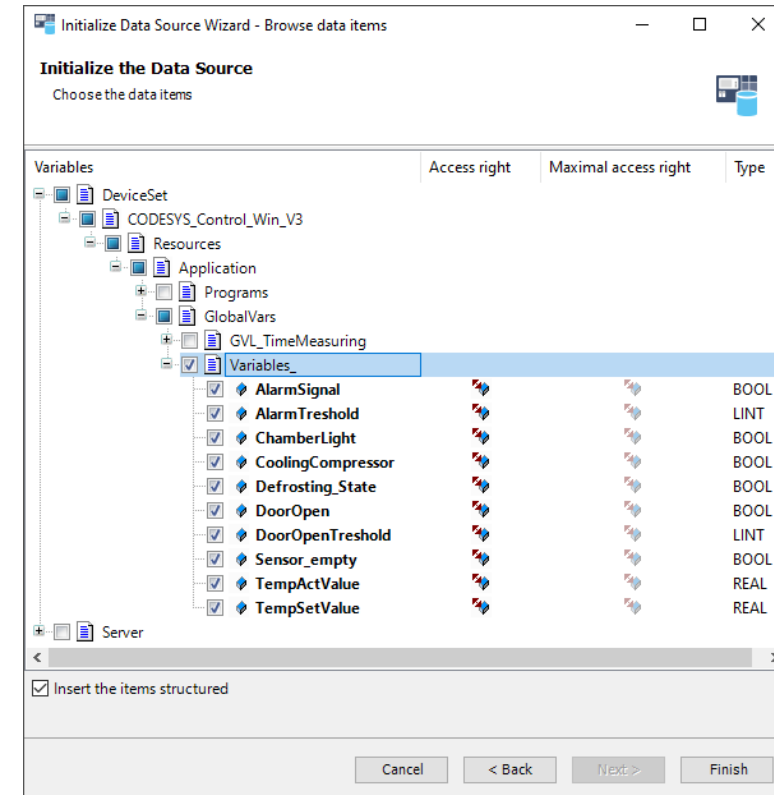
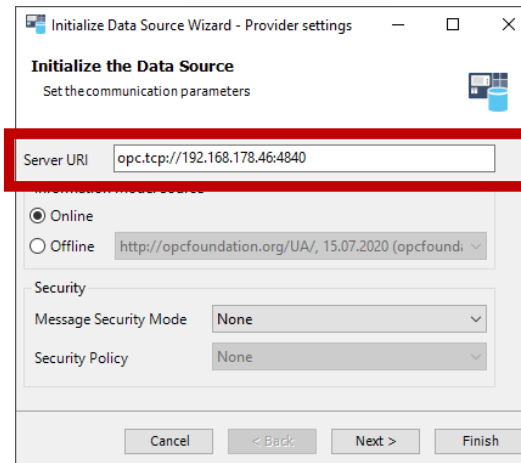
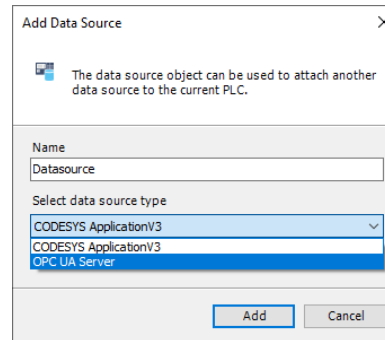
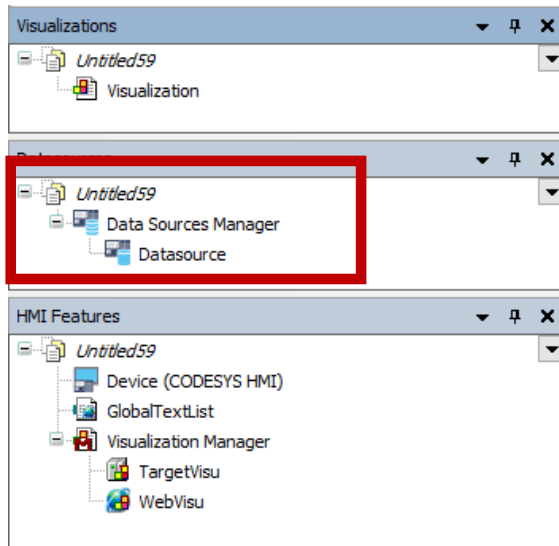

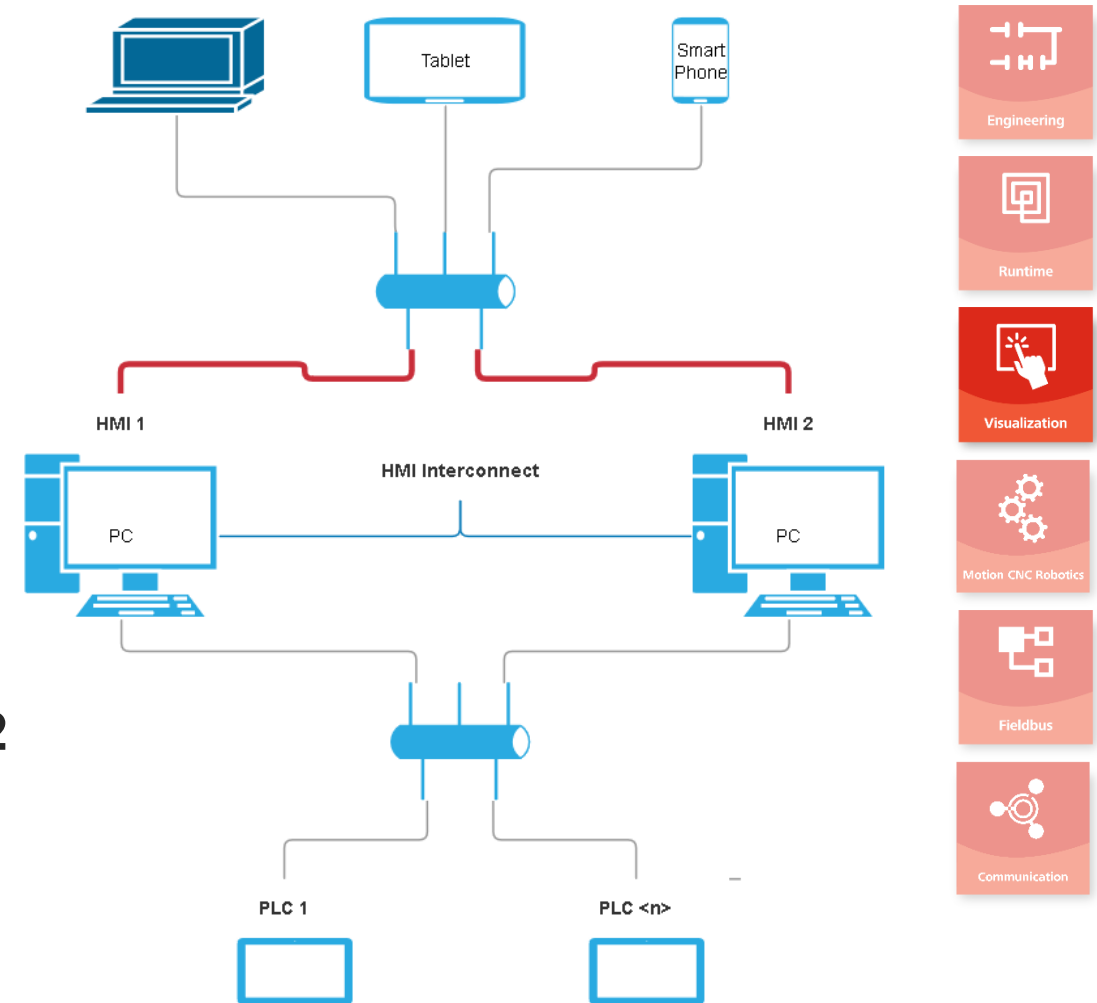

## HMI redundancy

- Synchronization of WebVisu client information between HMI master and slave
- In case of failure of HMI master: All WebVisu clients are automatically switched to the other HMI
  - Clients remain on pages/frames as before.
  - Login remains
- Immediate start of data transfer from the new HMI master to the controllers
- Central display of alarms either in HMI1 or HMI2 using remote alarm configurations
- Remote trend recording possible
- First release: no synchronization of recipes



## HMI redundancy - configuration

- Visualization redundancy is not bound to CODESYS HMI SL.
- Enabled within the general redundancy configuration
- Automatic enabling via libraries and generated code possible

 VisuRedundancy = VisuRedundancy, 3.5.17.0 (System)	VisuRedundancy	3.5.17.0
 RedundancyDataTransfer = RedundancyDataTransfer, 3.5.17.0 (System)	RDT	3.5.17.0
 NetBaseSrv = Net Base Services, 3.5.17.0 (3S - Smart Software Solutions GmbH)	NBS	3.5.17.0

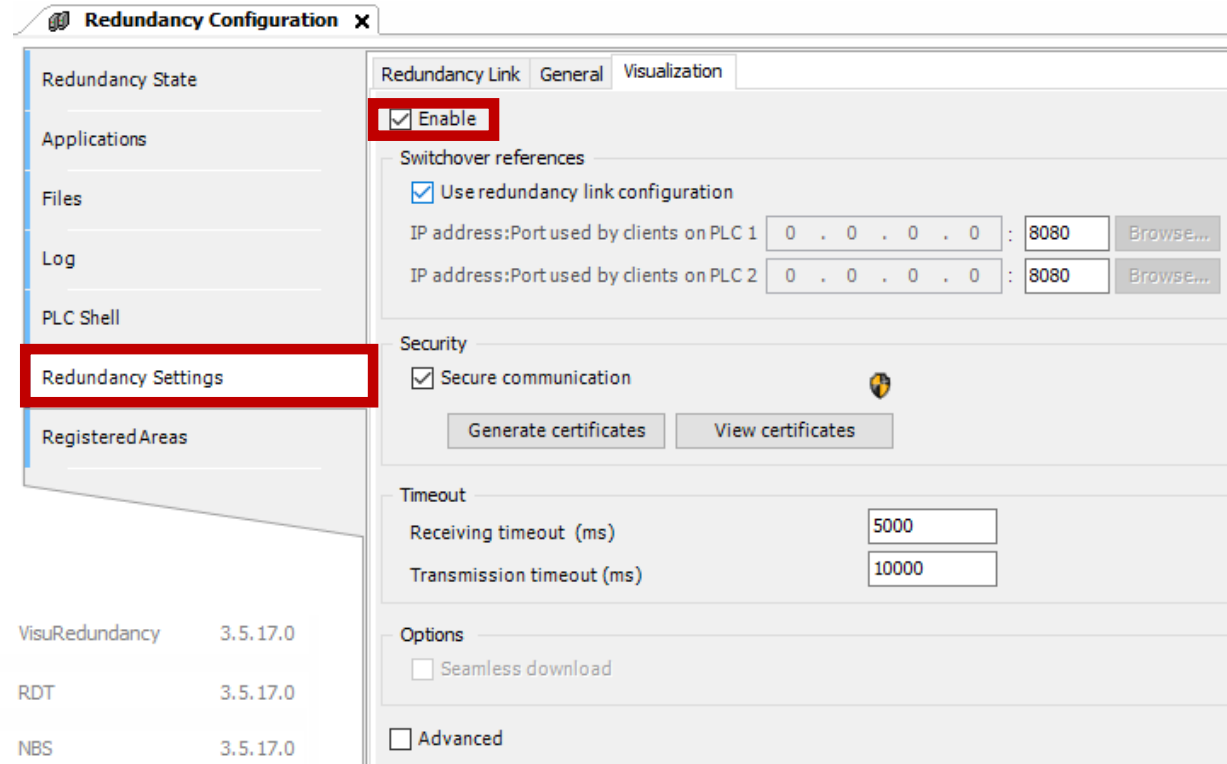

**Redundancy Configuration**

Redundancy State

Applications

Files

Log

PLC Shell

**Redundancy Settings**

Registered Areas

Redundancy Link | General | Visualization

**Enable**

Switchover references

Use redundancy link configuration

IP address:Port used by clients on PLC 1: 0 . 0 . 0 . 0 : 8080

IP address:Port used by clients on PLC 2: 0 . 0 . 0 . 0 : 8080

Security

Secure communication 

Timeout

Receiving timeout (ms):

Transmission timeout (ms):

Options

Seamless download

Advanced



Engineering



Runtime



Visualization



Motion CNC Robotics



Fieldbus



Communication

## Improvements of Trend

- Interruptions in the trend recording (PLC Start/Stop) visible as gaps
- Possibility to stop the recording of single variables
- Dynamic limits for minimum / maximum of Y axes via IEC variables
- Trend legend with optional checkboxes to hide / show individual variables
- Possibility to reset the trend recording in the database
- Search / replace within the trend recording now possible

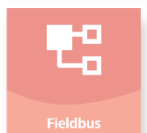
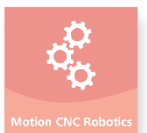
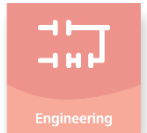

## Improvements of alarm management

- **Possibility to readout all information of a selected alarm**  
Both active and historical alarms
- **Complete alarm record can be reset via IEC application**

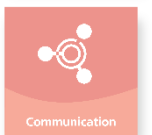
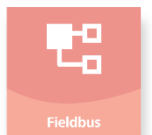
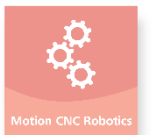
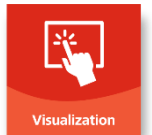
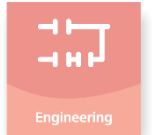

## Further improvements

- **Support of the LDATE, LTOD, LDT, LTIME data types within visualization, alarm management, and recipe management**
  - Support in the Date and Date / Time Picker elements as well as in the formatted output / input with %t
  - Support of alarm conditions and latch variables
  - Support of variables in recipe definitions
- **Option to display scrollbars for scrollable elements like frame, table, combo box and alarm table when "Multitouch handling" is enabled.**
- **WebVisu FileTransfer - dialogs for the file transfer can be customized in size and design.**

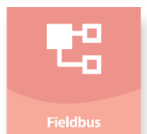
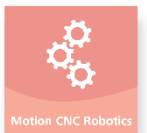
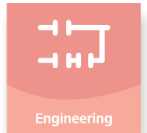
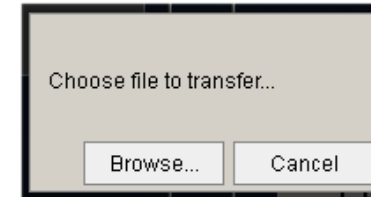
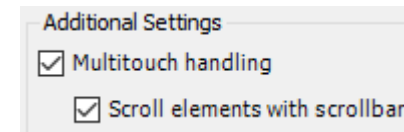



## Further improvements

- **Interface/callback:** For tracking all inputs on elements
- **New format string for TIME variables to enter REAL values**  
Examples:
  - %t[hh4] or %t[HH4], hours with 4 decimal places
  - %t[mm2] or %t[m2], minutes with 2 decimal places, e.g. 40.25 minutes
  - %t[ss0], seconds without decimal places.
- **Recipe management: new option**  
→ **Recipes are / are not overwritten during download.**

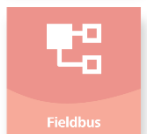
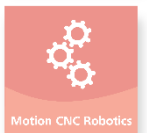
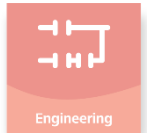
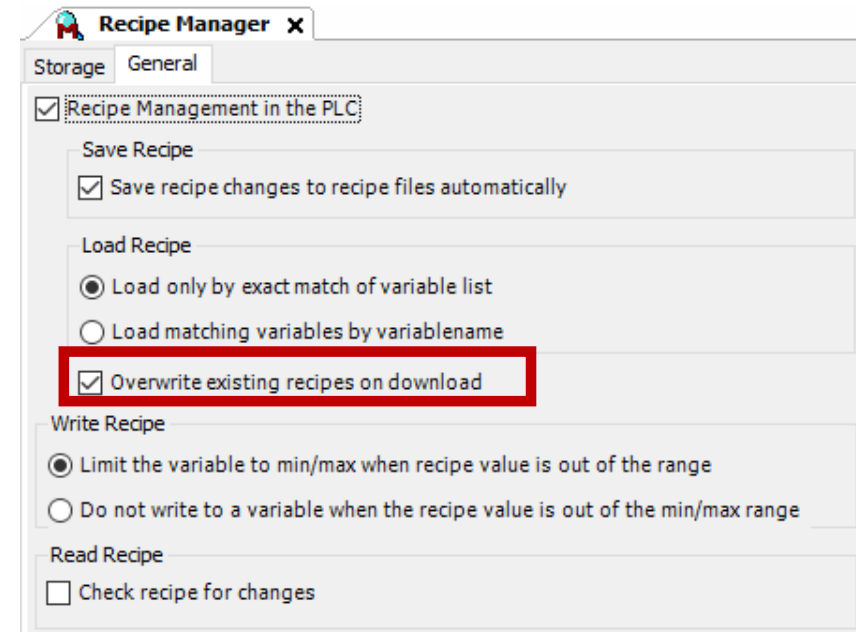

## Further improvements

- **Output of the number of used variables within all visualizations**

The screenshot shows the 'Device' configuration window with the 'Licensed Software Metrics' section expanded. A table lists the following metrics:

Metric	Size	Unit
Size of User Code	795280	Byte
Application	795280	Byte
Variables used in visualizations	320	Variables
Application	320	Variables

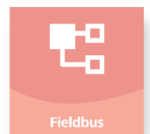
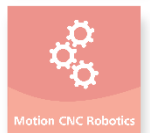
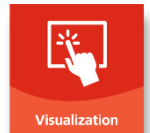

1

**Engineering**

2

**Runtime**

3

**Visualization**

4

**Motion CNC Robotics**

5

**Fieldbus**

6

**Communication**

## Overview

- **SoftMotion on Standard PLCs**
- **Robotics improvements**
- **New supported drives**

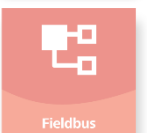
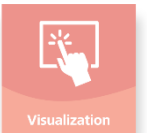
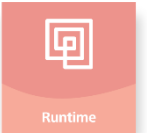
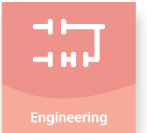

## SoftMotion on Standard PLCs

- **Previously: SoftMotion only on devices with special target type = 0x1006**
- **New: SoftMotion can be run on all PLCs.**
- **Activation via new command "Enable SoftMotion"**  
 → SoftMotion objects (CAM editor, CNC editor, axis groups) can now also be inserted on standard PLCs.
- **Advantage for users: easier upgrade**
  - of CODESYS compatible devices
  - of SoftPLCs from the CODESYS Store ("SL Runtimes")

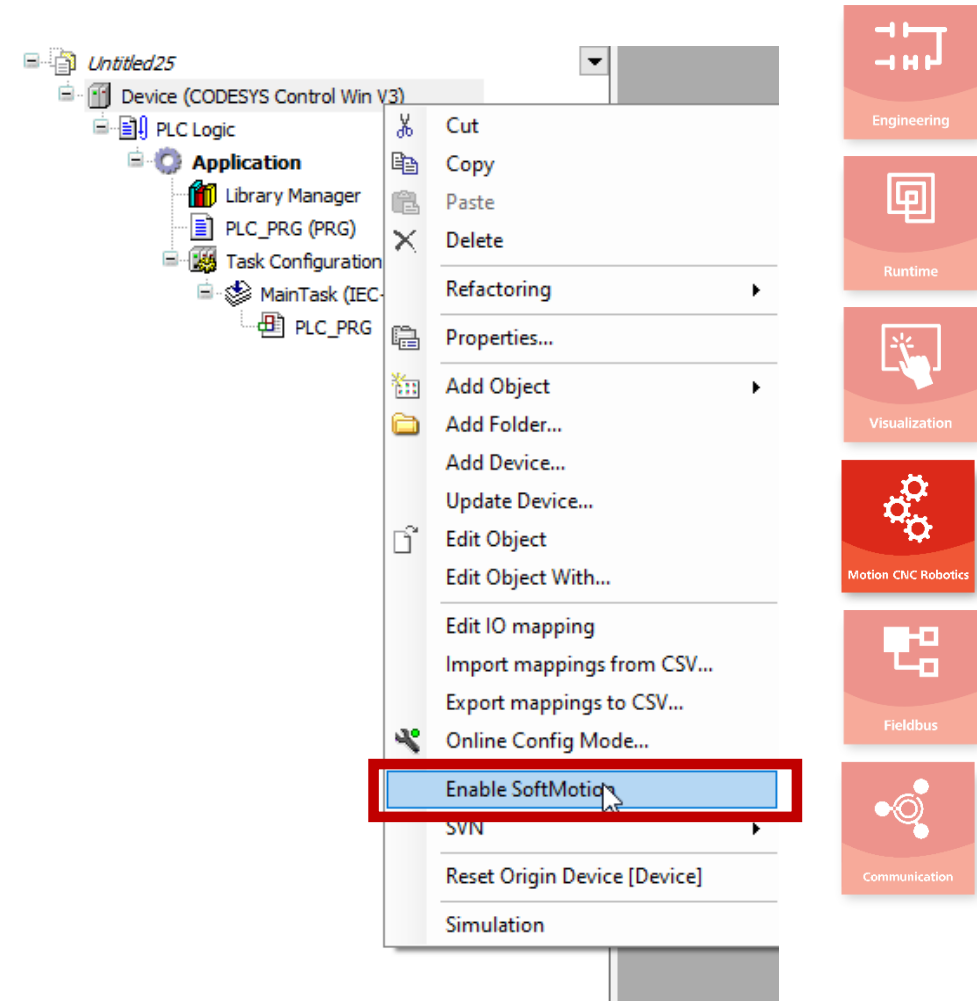

## Robotics improvements

- **Improved jogging**
  - Jogging = moving robot in manual mode
  - Improved orientation jogging:  
Robot rotation more predictable
  - Fixing of numerous bugs
  - Improvement of test coverage
  - Improved documentation and error messages
- Note: SMC\_GroupJog2 replaces SMC\_GroupJog  
(will be discontinued)

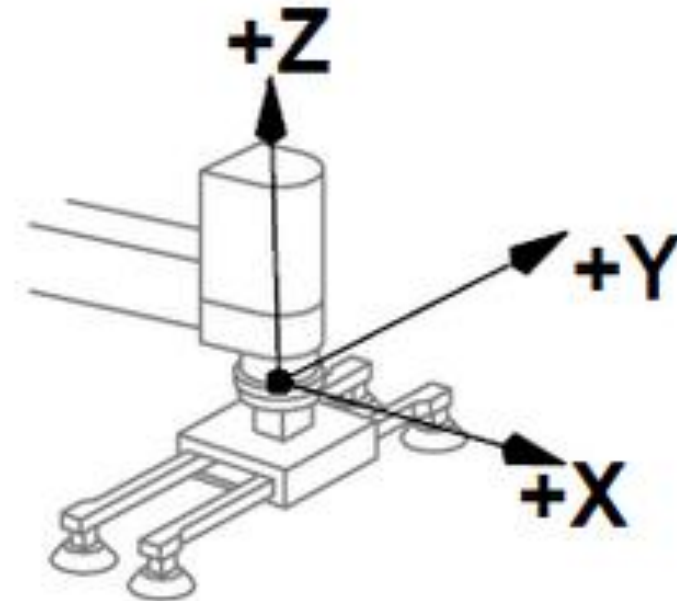

Engineering



Runtime



Visualization



Motion CNC Robotics



Fieldbus



Communication

## Robotics improvements

- **SMC\_GroupInterruptAt**
  - Stopping at a certain position on the path
  - Otherwise like SMC\_GroupInterrupt (pausing on the path)

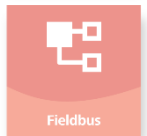
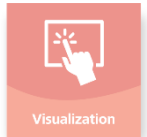
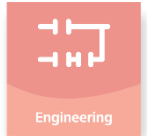
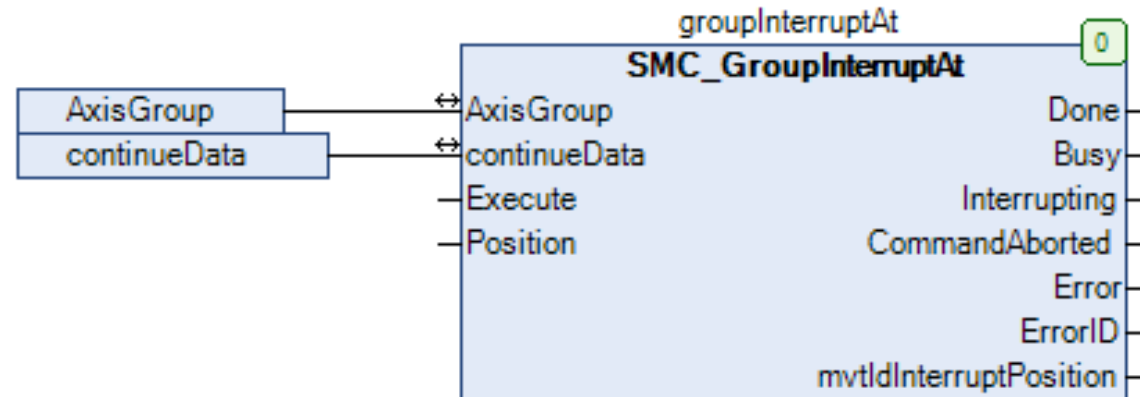

## New supported drives

- Bosch Rexroth IndraDrive CS
- Delta Remote IO
- Delta ASDA A3/B3
- Beckhoff EL7041/7047

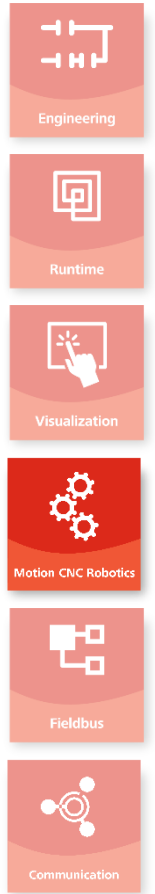
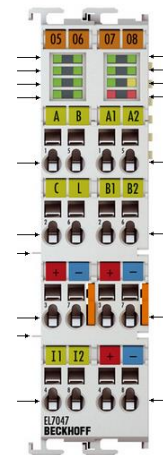



1

**Engineering**

2

**Runtime**

3

**Visualization**

4

**Motion CNC Robotics**

5

**Fieldbus**

6

**Communication**

## Overview

- **General improvements**
- **EtherNet/IP**
- **CAN / CANopen / J1939**
- **EtherCAT**
- **PROFINET**
- **MODBUS**

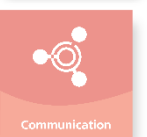
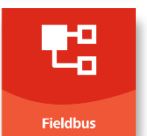
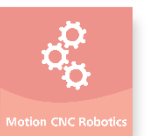
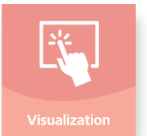
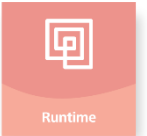
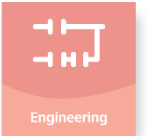

## General improvements

- **Implicitly generated fieldbus task:**
  - Warning when deleted
  - Easy way for restoring deleted task

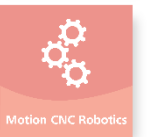
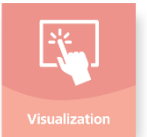
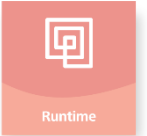
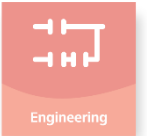

## EtherNet/IP

### Scanner

- LargeForwardOpen for Scanner and Adapter:  
Up to 65527 bytes per connection (before: 512 bytes)!
- EtherNet/IP Scanner:  
Possibility of enabling filling bytes in I/O mapping
- Stability improvements for multiple connections per slave
- GUI: Many bug fixes and performance improvements  
→ Update recommended!

### Adapter

- Possibility for sending outputs on start of bus cycle:  
Possible reason for doing so: less Jitter
- Extension of Ethernet Link Object:  
Conformance test with 1 GBit possible

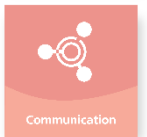
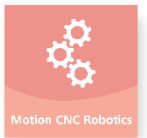
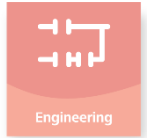

## CAN (CANopen/J1939)

- **General rework of online help with focus on diagnosis**
  - New structure: Configuration, Functions, Libraries, Diagnosis
  - Diagnosis chapter added
    - Diagnosis in application
    - Diagnosis in user interface
    - Troubleshooting

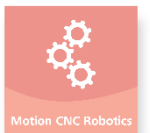
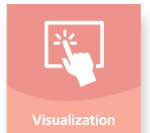
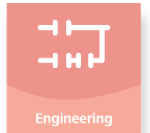
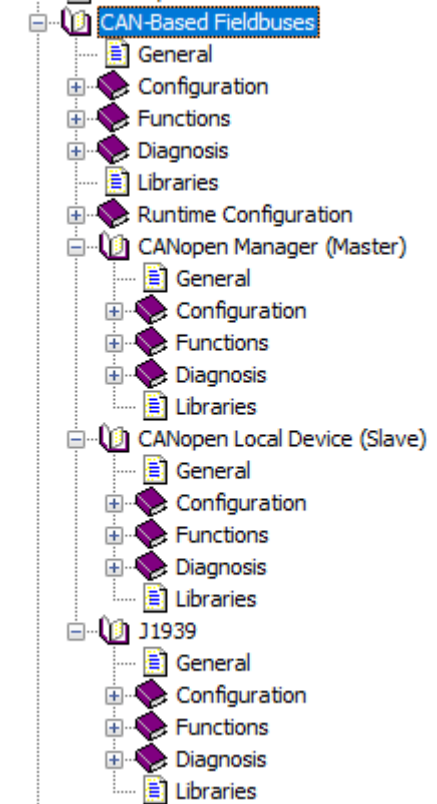

## CAN (CANopen/J1939)

### Troubleshooting

#### CANbus

Problem	Possible Solution
The CANbus is red in the device tree directly after the application download.	<p>Check the status page and logger page of the CAN bus. You will find more information here.</p> <p>Possible causes:</p> <ul style="list-style-type: none"> <li>The driver could not be opened:                             <ul style="list-style-type: none"> <li>The network ID is set too large. In the CAN bus, a network ID was set for which there is no driver instance. If there are multiple interfaces, then valid values for the network ID are only 0 and 1.</li> <li>The driver component was not loaded in the runtime. Check whether the CAN driver component has been loaded correctly (see the "Configuration" chapter).</li> <li>The memory is insufficient. Opening the CAN driver requires memory. Too little memory may be available.</li> </ul> </li> <li>A bus error has occurred:                             <ul style="list-style-type: none"> <li>The CAN chip signals a bus error. See the chapter "Diagnosis of Hardware Failures".</li> </ul> </li> </ul>

#### Diagnosis of Hardware Failures

Most CAN problems are traced back to incorrect wiring or faulty CAN devices. Potential errors include the following:

- Missing or incorrectly dimensioned terminal resistors  
The bus has to be terminated exactly with a 120 Ω terminal resistance at the beginning and at the end.
- Different baud rates  
All subscribers have to use the same baud rate.
- Short circuit between CANLow, CANHigh, CANGround, V+
- CANLow and CANHigh interchanged
- Different lengths of CANHigh and CANLow
- CANHigh and CANLow are not a twisted pair. As a result, signals can be interrupted more easily.
- Different grounding sources for CANGround
- Two-sided grounding of the CAN bus cable  
When both ends of the shielding of the CAN bus cable are grounded, grounding loops can form which can cause interruptions.
- Bus cable too long  
The maximum bus length depends on the set baud rate (see table).

Bit Rate	Cable Length
10 kbps	6.7 km
20 kbps	3.3 km
50 kbps	1.0 km
125 kbps	500 m
250 kbps	250 m
500 kbps	125 m
1 Mbps	25 m

#### Detecting hardware failures



Engineering



Runtime



Visualization



Motion CNC Robotics



Fieldbus



Communication

## CAN (CANopen/J1939)

### ▪ Modularization

- Stack library placeholders:  
Now part of the CANopenManager, CANopenSlave, and J1939Manager device
- Using new protocol stack:  
Before: „Update device“ for PLC necessary → New runtime required  
New: „Update device“ on the corresponding stack device (e.g. CANopenManager) possible

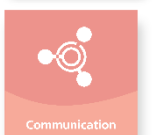
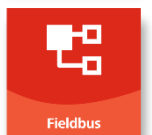
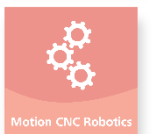
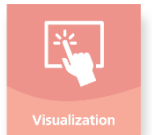
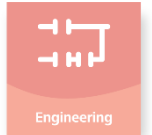

# CANopen

- **CANopen Manager**

- Improved COB-ID collision detection and intelligent suggestions
  - Additional check for EMCY, SYNC and TIME COB-ID
  - Check & Fix dialog suggests COB-ID formulas where possible.

Name	Object	Bit length
<input checked="" type="checkbox"/> <b>16#1400: Receive PDO Communication Parameter</b>	<b>16#202</b>	<b>16</b>
DigOutput8_1	16#6200:16#01	8
DigOutput8_2	16#6200:16#02	8
<input checked="" type="checkbox"/> <b>16#1401: Receive PDO Communication Parameter</b>	<b>16#202</b>	<b>64</b>
Write Analogue Output 1	16#6411:16#01	16
Write Analogue Output 2	16#6411:16#02	16
Write Analogue Output 3	16#6411:16#03	16
Write Analogue Output 4	16#6411:16#04	16



Device name	Node-ID	Object	Formula	Conflicted COB-ID	Automatic Suggestion
BK5120	1	PDO 16#1400	16#202	16#00000202	<input type="text" value="\$NODEID+16#200"/>
BK5120	1	PDO 16#1401	16#202	16#00000202	<input type="text" value="\$NODEID+16#300"/>

- **CANopen Slave**

- PDO/SRDO communication settings of I/O areas can be edited.

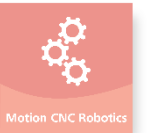
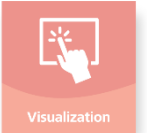
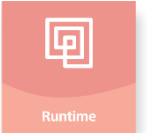
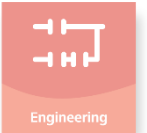



## J1939

- **Import function for DBC**

- Proprietary file format from Vector Informatik for defining CAN messages and ECUs
- Widely used by Commercial Vehicle Manufacturers
- Different use cases (see following slides)

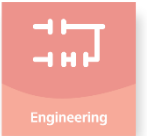

Engineering

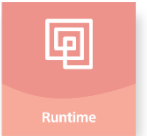

Runtime

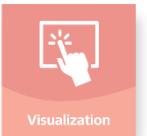

Visualization

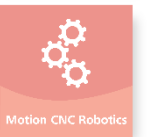

Motion CNC Robotics



Fieldbus



Communication

## J1939

### Use case 1: Import a complete network

The image illustrates the steps to import a complete network in CODESYS:

- Import DBC File:** In the 'Application' tree, right-click and select 'Import DBC File...'.
- DBC content selection:** A dialog box showing a list of components to import. The 'TECU' (Transmission ECU) is selected.
- TECU Configuration:** The 'TECU' configuration window is shown with 'SAE J1939' selected and 'ECU NAME' set to '300E8A9344E'.
- Find Table:** A table showing the mapping of variables from the DBC file to the project. The table includes columns for Variable, Mapping, Channel, Address, Type, Unit, and Description.

Variable	Mapping	Channel	Address	Type	Unit	Description
TCFG2_TECU	TransTargetLimit	TransTargetLimit	%M292	UBINT	mm	
TCFG_TECU	NumberOfReverse...	NumberOfReverseGearRatios	%M586	USINT		
	NumberOfForward...	NumberOfForwardGearRatios	%M587	USINT		
	TransGearRatio	TransGearRatio	%M147	REAL		
SOFT	NbrOfShiftIdent...	NbrOfShiftIdentificationFields	%M592	USINT	steps	
	SoftwareID_1	SoftwareID1	%M595	USINT		
	SoftwareID_2	SoftwareID2	%M594	USINT		
	SoftwareID_3	SoftwareID3	%M595	USINT		
ETC7_TECU	TransRangeD...	TransRangeDisplayBankState	%M596	USINT		
	TransRangeD...	TransRangeDisplayBankState	%M597	USINT		
	TransReadyForBra...	TransReadyForRelease	%M598	USINT		
	ActiveShiftConsol...	ActiveShiftConsoleIndicator	%M599	USINT		
	TransEngCrankEna...	TransEngCrankEnable	%M600	USINT		
	TransShiftInhibit...	TransShiftInhibitIndicator	%M601	USINT		
	TransModeIndicator	TransModeIndicator	%M602	USINT		
	TransModeIndicator	TransModeIndicator	%M603	USINT		
	TransModeIndicator	TransModeIndicator	%M604	USINT		
	TransModeIndicator	TransModeIndicator	%M605	USINT		
	TransGearFeedba...	TransGearFeedback	%M303	INT		
ETC2_TECU	TransSelectedGear	TransSelectedGear	%M304	INT		
	TransActualGearRat...	TransActualGearRatio	%M153	REAL		
	TransCurrentGear	TransCurrentGear	%M308	INT		
	TransGearRange	TransGearRange	%M309	USINT		
	TransCurrentRange	TransCurrentRange	%M310	USINT		
ETC1_TECU						
ECU20						
DM5						
DM4						
DM25						
DM24						
TRF1_TECU						



Engineering



Runtime



Visualization



Motion CNC Robotics



Fieldbus



Communication

## J1939

### Use case 2: Install as database

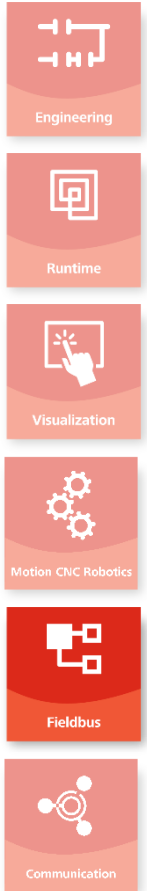
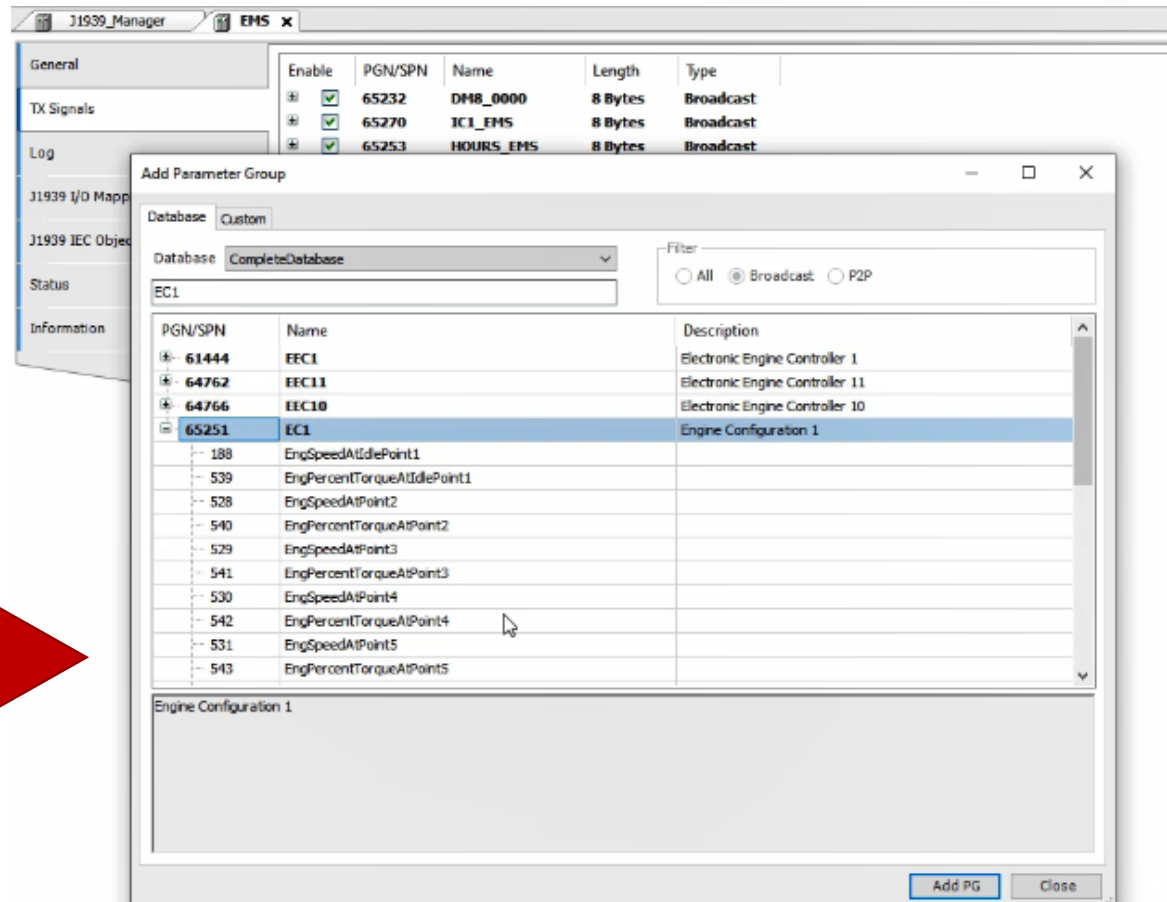
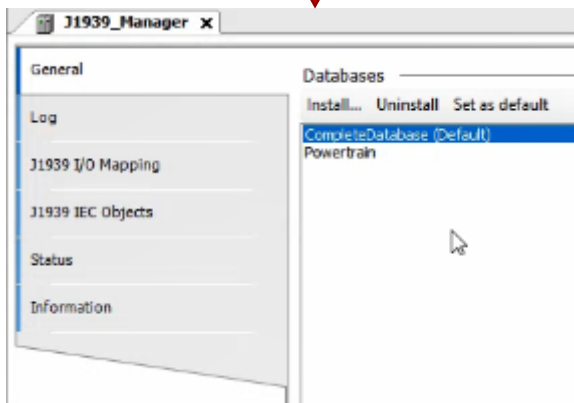
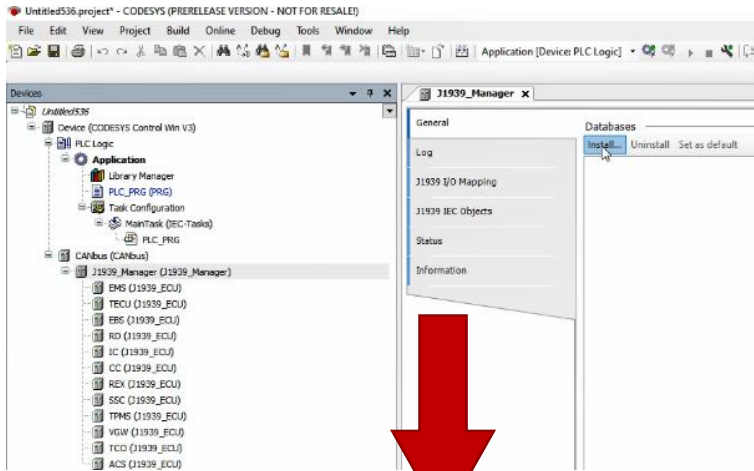

## J1939

- **Removal of standard database**
  - Tooltip and online help notice the user!
  - User has to buy a DBC database e.g. from <https://www.csselectronics.com/>

Discount Code (5%):  
*J1939DBC\_CODESYS*

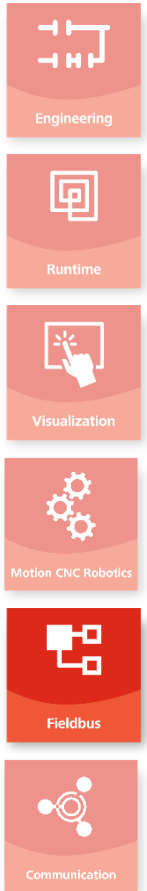
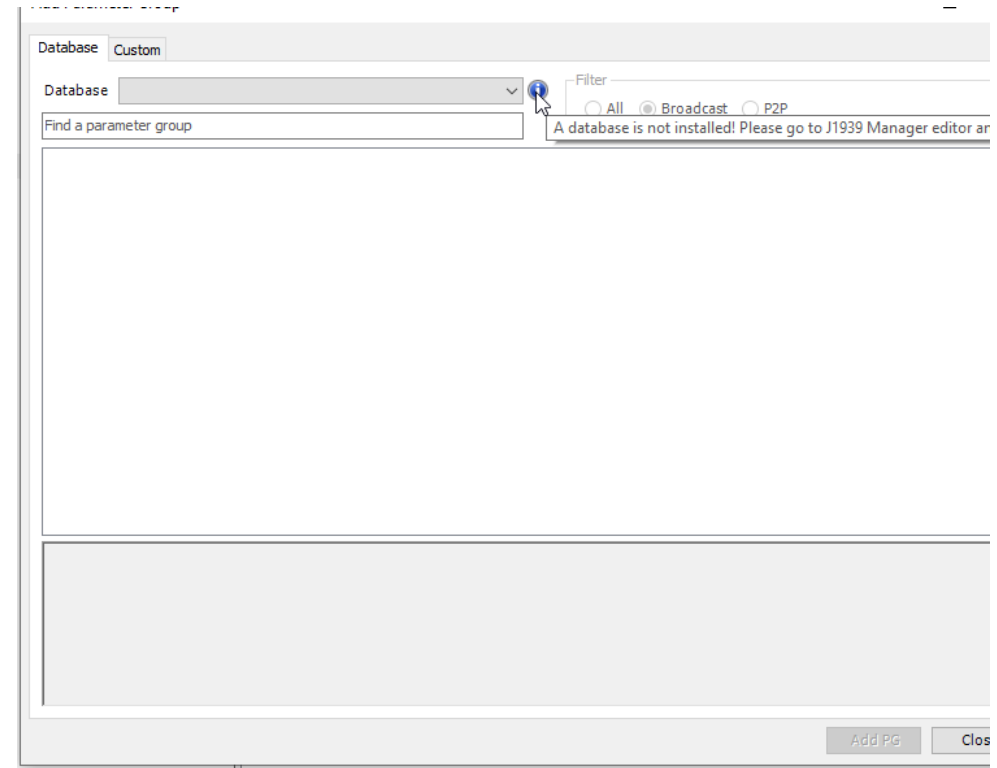

## EtherCAT

- Online page shows Link-Status
- Routing of EoE
- Overview page for device status

Name	Address	State	CRC
EK1100	1001	OP	0, 0
EL2008	1002	OP	0, 0
EL1008	1003	OP	0, 0
EL3142	1004	OP	0, 0
EL4132	1005	OP	0, 0
EK1122	1006	OP	0, 0, 0
AXL_F_BK_EC	1007	OP	0
EK1122_1	1008	OP	0

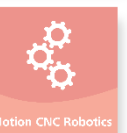
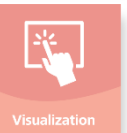
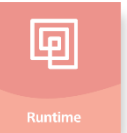

## PROFINET

- **Performance optimizations**  
Up to 40% lower bus cycle times
- **Support dual- / multi-port Ethernet interfaces**  
→ Build controllers and devices with up to 8 Ethernet ports, e.g. for „Daisy Chain“ use case
- **Create PROFINET Device \*.devdesc from GSDML**  
→ No more manual steps for manufacturers of PROFINET Device



Engineering

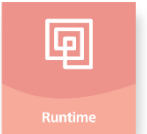

Runtime

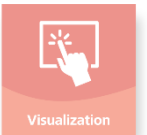

Visualization

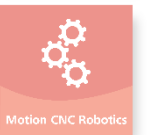

Motion CNC Robotics

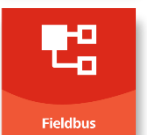

Fieldbus



Communication

## PROFINET

- **PROFINET Device: programmatic configuration**
  - No Device-objects in static device tree
  - Completely programmatic, function block-based configuration (Library „ProfinetDeviceConfig“)

```
12  VAR
13      pnDevice : ProfinetDeviceConfig.ProfinetDeviceInstance;
14      deviceIdent : ProfinetDeviceConfig.DeviceIdentification;
15
16  //Startup:
17  IF (NOT pnDevice.xInit) THEN
18      deviceIdent.deviceID := 16#1017;      // Device Config
19      deviceIdent.vendorID := 16#02CC;
20      //...
21      pnDevice.Plug(in32);      //Plug Modules
22      pnDevice.Plug(out32x8);
23      pnDevice.Plug(out32_param);
24      //...
25      pnDevice.ConfigureDevice(interfaceName, deviceIdent); //Configure
26
27  ELSIF (NOT (pnDevice.xStartup OR pnDevice.xOnline)) THEN
28      pnDevice.Start();
29  END_IF
30
31  //Acyclic services of device:
32  pnDevice.ProcessServices();
```



Engineering



Runtime



Visualization



Motion CNC Robotics



Fieldbus



Communication

## PROFINET

### IO-Link integration

- Editor for settings of IO-Link Device (IODD based)
- Pre-processed IO data
- Diagnosis with textual information from IODD
- Scan / import of IO-Link sensors

The screenshot displays the CODESYS software interface for configuring an IO-Link device. On the left, a 'Devices' tree shows a project named 'IOL\_Example' containing a 'Device [connected] (CODESYS Control RTE V3 x64)'. Underneath, there are sections for 'PLC Logic', 'Ethernet (Ethernet)', and 'PN\_Controller (PN-Controller)'. The 'al1400 (AL1402)' device is expanded to show 'al1400\_1 (8 Ports)', which includes 'IOLM (IO-Link Master Proxy 8P)' and four 'X1\_B\_Port' through 'X4\_B\_Port' ports. Below this, 'IOLD\_Port5 (IO-Link 32 I / 32 O E)' and 'OMT300\_R200\_series (OMT300 R)' are listed, with 'IOLD\_Port6 (IO-Link 32 I / 32 O E)' also visible.

The right pane shows the configuration for the selected 'OMT300\_R200\_series' device. It includes tabs for 'IO-Link Device Info', 'IO-Link Parameter', 'Information', and 'Status'. The 'IO-Link Parameter' tab is active, displaying the 'PEPPERL+FUCHS' logo and a 'User role' dropdown set to 'Maintenance'. There are radio buttons for 'Identification menu' and 'Parameter menu', with 'Parameter menu' selected. A 'Set to Defaults' button is also present.

Name	Value	Unit
Operation Parameter		
Switching Signal Channel 1		
SP1	250.0	mm
SP2	150.0	mm
Logic	High active - Not Inverted	
Mode	Window	
Hysteresis	Standard	
SSC1 Config - SP Offset	30.0	mm
Switching Signal Channel 2		
Teach-In		

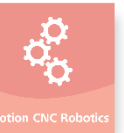
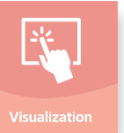
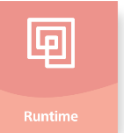
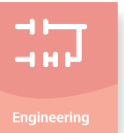



# MODBUS

## MODBUS function block library

- Completely programmatic, function block-based configuration and communication
- Client + server
- TCP + serial
- Various examples in CODESYS Forge

The screenshot displays the CODESYS software interface for the ModbusFB library (version 3.5.17.0). The left sidebar shows the library structure, including Library Information, ModbusFB, Enums, and Function Blocks. The main window shows the definition of the ClientRequestReadBits function block, which is a client-side function for reading bits from a Modbus device.

**ClientRequestReadBits**

Input	Type	Default Value	Output	Type
xExecute	BOOL		xDone	BOOL
udiTimeOut	UDINT		xBusy	BOOL
rClient	Client		xError	BOOL
[uiUnitId	UINT	:= 0]	Error	eErrorID
[udiReplyTimeout	UDINT	:= (50 * 1000)]	ExceptionCodes	eException
[uiMaxRetries	UINT	:= 0]	uiRetryCnt	UINT
[uiStartItem	UINT	:= 0]		
[uiQuantity	UINT	:= 1]		
[pData	POINTER TO ARRAY [0..0] OF BOOL	:= 0]		



Engineering



Runtime



Visualization



Motion CNC Robotics



Fieldbus



Communication

1

**Engineering**

2

**Runtime**

3

**Visualization**

4

**Motion CNC Robotics**

5

**Fieldbus**

6

**Communication**

## Overview

- **OPC UA Server/Client improvements**
- **OPC UA PubSub communication**
- **IIoT Library Bundle improvements**

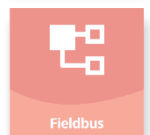
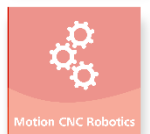
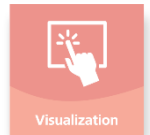
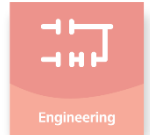

## OPC UA Server/Client improvements

- **Support of OPC UA methods**
  - Use case: call functions and methods of IEC applications and start complex functional processes via OPC UA
- **Support of OPC UA alarms & conditions**
  - Use case: send and acknowledge alarms to and with a capable OPC UA client
  - Events signal a change of the alarm status to the client
  - The client uses methods to interact with a specific instance of an alarm or condition.
- **Implementation of new security profiles defined in OPC UA 1.04 (CDS-62076)**
  - Basic125Rsa15 and Basic256 message security policies have been deprecated.
  - Two new security profiles: Aes128Sha256RsaOaep (for medium security needs) and Aes256Sha256RsaPSS (for high security needs)

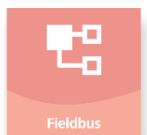
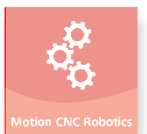
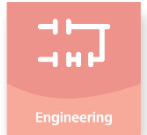

## OPC UA Server/Client Improvements

- Support of OPC UA Client configuration via Data Sources

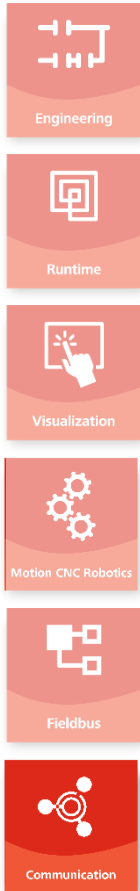
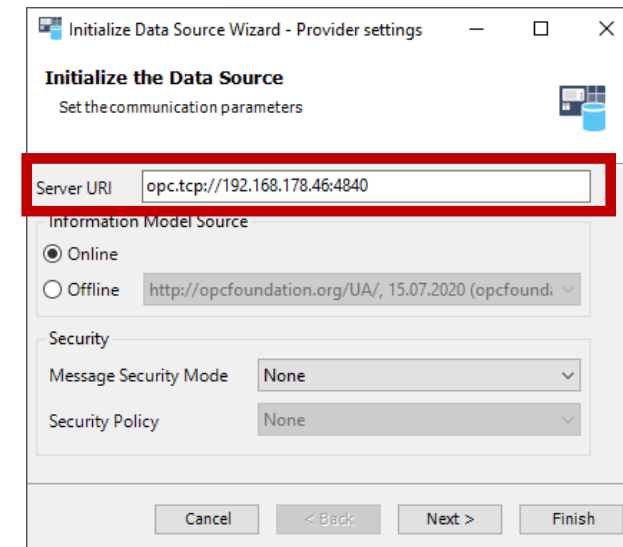
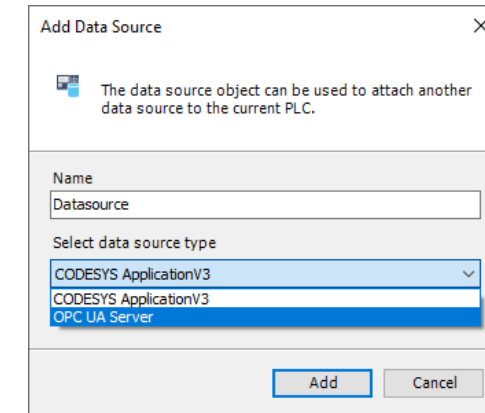
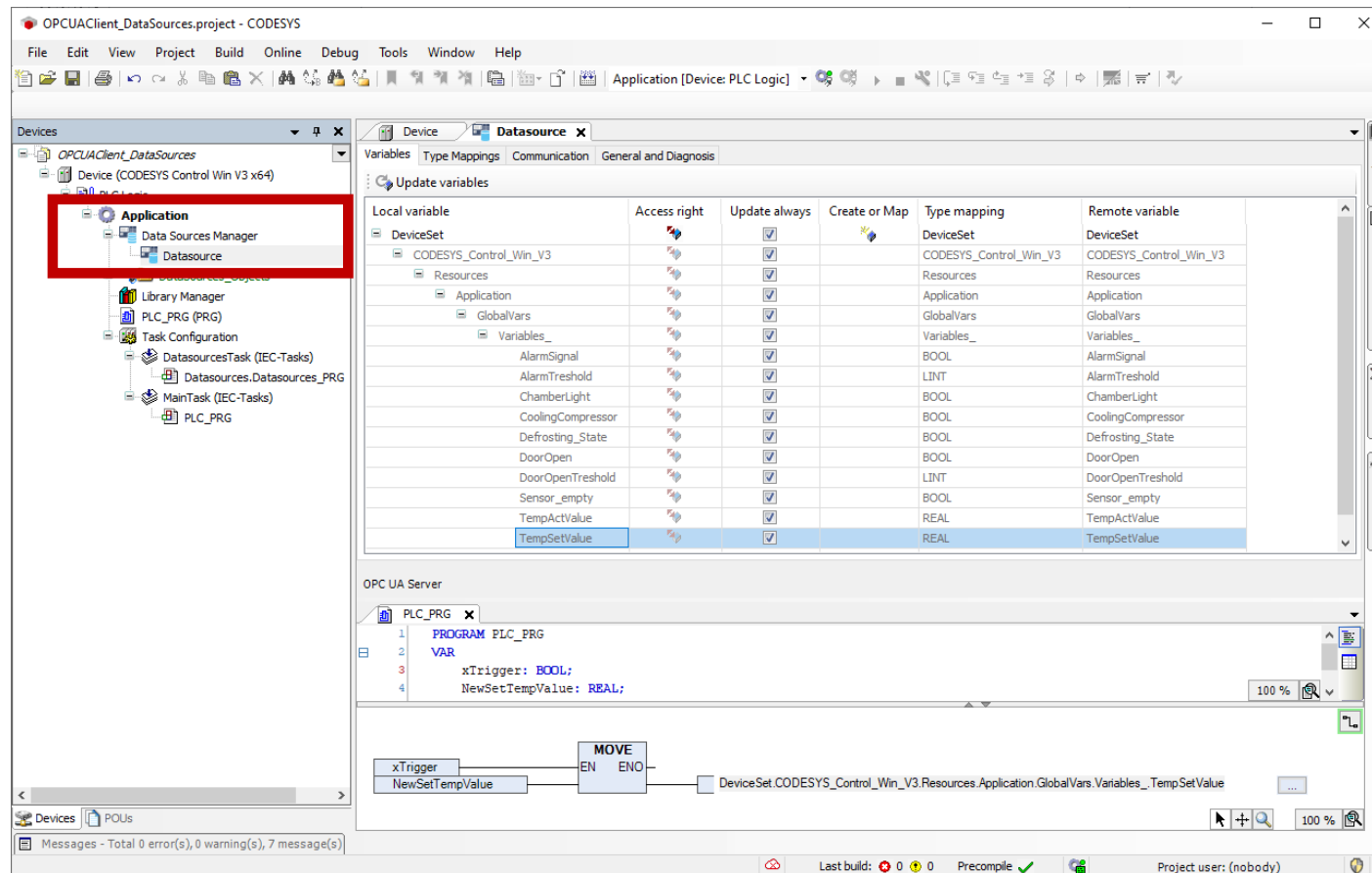

## OPC UA information models / companion specifications

- Support of user-defined information models / companion specifications

The screenshot illustrates the workflow for adding a user-defined OPC UA Information Model in CODESYS. It is divided into three main sections:

- Left Panel:** Shows the 'Devices' tree with the 'Application' selected. A context menu is open, and 'Communication Manager...' is highlighted. The 'Add OPC UA Information Model' dialog is also visible, with 'OPC\_UA\_Symbols' entered in the 'Name' field and the URI 'http://opcfoundation.org/UA/, 15.07.2020 (opcfoundation.org)' in the 'Information Model URI' field.
- Middle Panel:** Shows the 'Information Model' browser. The 'OPC\_UA\_Symbols' folder is highlighted in the tree. The 'Generate IEC declarations' button is highlighted in red.
- Bottom Panel:** Shows the 'OPC\_UA\_Symbols [https://codesys.com/UA/objecttest/]' window. It contains a table of mapped instances:

OPC UA Variable	OPC UA Type	Map or create	IEC Variable	IEC Type	Access Rights	Maximal
inst_1	TestRootObjectType		OPC_UA_Symbols.inst_1	TestRootObjectType		
inst_2	TestRootObjectType		OPC_UA_Symbols.inst_2	TestRootObjectType		
Inst2	TestRootObjectType		PLC_PRG.Inst2	TestRootObjectType		

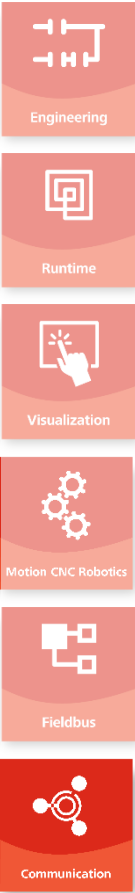

## IloT Library Bundle improvements

- **Extension of the functional scope**
  - Now with function blocks for data exchange with Google Cloud IoT Core
  - License for Google Cloud IoT Core Client SL included in the **IloT Libraries SL**

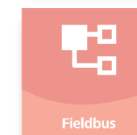
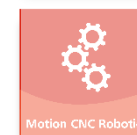
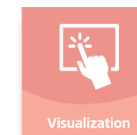
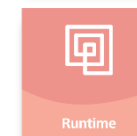



**Thank you for your attention!**

CODESYS® is a registered trademark. Technical specifications are subject to change.

Errors and omissions excepted. No reproduction or distribution, in whole or in part, without prior permission.

Note: Not all CODESYS features are available in all territories. For more information on geographic restrictions, please contact [sales@codesys.com](mailto:sales@codesys.com).